

**LUCY+ JORGE ORTA: POTENTIAL ARCHITECTURE**

Cells are a part of the human body; they are at the origin of its being, its feelings, its emotions, and its sufferings. Thus, they speak the language of the body. There are also cells of habitation. The relationship between people and their habitat is formed in this metaphorical cell. Living and being become a single and unique life experience. CRISTINA MOROZZI

*Potential Architecture* explores artists Lucy+Jorge Orta's recent architectural endeavors that derive from their fascination with cell biology and the process of differentiation. Through drawings and sculpture, the artists conceptualize the communication process the human cell undertakes from its embryonic state, and the infinite transformations that lead to defined structural organisms.

This new body of work draws from Lucy+Jorge Orta's artistic practice, grounded in the universal concerns of community, shelter, migration, and sustainable development.

*Potential Architecture* is a powerful rejoinder to the arbitrary boundaries that define art, architecture, and design.

POTENTIAL ARCHITECTURE



LUCY+JORGE ORTA

[DAMIANI]

# POTENTIAL ARCHITECTURE



LUCY+JORGE ORTA

[DAMIANI]



# LUCY+JORGE ORTA

---

# POTENTIAL ARCHITECTURE

---

LUCY+JORGE ORTA  
Potential Architecture

© Damiani 2013  
© The Artists for the Artworks  
© The Authors for the Texts

All rights reserved. No part of this publication may be reproduced or transmitted in any form or by any means, electronic or mechanical - including photocopying, recording or by any information storage or retrieval system without prior permission in writing from the publisher.

Editor Lucy Orta  
Editorial coordination Amanda Sarroff / Camilla Palestra  
Design Ellen Gögler / npeg.fr  
Printed June 2013 – Grafiche Damiani, Bologna, Italy

With the support of Arts Council England South East  
In collaboration with Centre for Sustainable Fashion, University of the Arts London;  
University of Southampton; Arts University Bournemouth

Published to coincide with the exhibition *Lucy + Jorge Orta: Potential Architecture*  
at TheGallery, Arts University Bournemouth, 7 September – 7 November 2013

[DAMIANI]

Damiani  
Via Zanardi, 376 – 40131 Bologna, Italy  
T +39 051 63 56 811 – F +39 051 63 47 188  
info@damianieditore.com – www.damianieditore.com

ISBN : 9788862082907

[DAMIANI]

## INDEX

<b>DENNA JONES</b> Organic Architecture 2005	9
<b>JAMES PUTNAM</b> The Shape of the Clouds and the Shape of Space and Time	23
<b>AMANDA SARROFF</b> Potential Architecture Les Moulins	48
<b>JOHN SCHOFIELD</b> Cellular Archaeology	95
<b>SASHA ROSENEIL</b> Architectures of Resistance and Transformation	117
<b>SIMON BEESON &amp; STEPHANIE JAMES</b> Potential Architecture Greenham Common Control Tower	130
<b>FRANCESCA COMISSO</b> Totipotent Architecture Atoll	133
Potential Architecture Nexus Bridge, Lee Bank Middleway, Birmingham	148
Potential Architecture Cellular Units, Cité du Design, Saint-Etienne	150
---	
Biography	154
Exhibitions Selection	155
Publications Selection	159
Artwork Captions	160



---

DENNA JONES

---

# Organic Architecture

2005

To the architect, the word cell means a small apartment, a room, a seclusion space for hermits, nuns or monks, a closet, a punitive incarceration area. In the age of al-Qaeda and surveillance surfeit, the cell is a seedbed of threat and hidey-hole for subversives (or, if you are on the side that wins, the think tank of the resistance). Poets use it as shorthand for graves, "their little cells within the burial-place." Robert Herrick, in his poem "A Thanksgiving for God, for His House" (1648), describes his wee cottage, his humble "cell wherein to dwell." For artists Lucy + Jorge Orta, the human cell is the portal through which they reach and reveal meaning for a body of work they call *Totipotent Architecture* to realize an array of mobile and permanent sculpture: "cells."

A Sciart Award received by Lucy Orta from the Wellcome Trust in 2004 prompted the artists to reflect on the question, how can our textile architectural studies become more organic and responsive to public space? Framework rhetoric follows, whereby the stem cell becomes Orta's metaphor for a "defined program of differentiation," for a set of new architectural units, within which the parameters are infinitely mutable. Through ensuing collaborative research with cell biologists Orta uses drawing to compare the role of stem cells with an imaginary communication theory. Predicated on advances in stem cell research enabled initially by the 1997 cloning of Dolly the sheep, stem cell lines can be purposely differentiated (i.e. specialized)

from one cell type to another. This "energy transformation"—whereby one cell becomes something completely different—references the approach Orta employ for their communication objectives of the recombinant, organic modular cells.

In 2004 Associazione Arte Continua commissioned a multi-installation, site-specific work *Totipotent Architecture* for the 9<sup>th</sup> edition of Arte Architettura Paesaggio. Six contemporary artists were selected to create work for six Tuscan villages. Orta were allocated Buonconvento, a thirteenth-century fortified town near Siena, and chose Museo d'Arte Sacra della Val d'Arbia (Museum of Sacred Art) and Porta Senese as the locations for *Totipotent Architecture*, *In Vitro*, *The Tower of Dreams*, and *Cinta Muraria*. Those familiar with Orta's body of work will instantly recognize the outstretched arms of the upper body section of multiple *Refuge Wear* hooded suits, hung in parallel lines down either side of the castellated town gate. Those unfamiliar might recognize the gesture's reference to religious iconography—the arms welcome but simultaneously echo Christ's suffering on the cross.

Orta's three installations in the Museum of Sacred Art possess a new authorial stamp visually unlike their previous iconic work. Colorless lead crystal—its structure suspended, like all glass, between a liquid and a solid—is shaped by the glassmaker's breath into loose, organic shapes with reference to

human cells. Reminiscent of the abstract shapes in Joan Fontcuberta's blood landscape *Hemograms* (1998), Orta's *In Vitro* glass cells sleep inside an antique iron ribcage crib and create a contemporary contrapposto with the tempera on panel painting, *The Annunciation* by Girolamo di Benvenuto (1470-1524), which hangs on the wall behind. The contrast is both physical and iconographic. A two-dimensional painting with a comprehensive tempera palette displayed next to a three-dimensional work of colorless crystal and black ironwork might, at first glance, seem incongruous. Yet their joint iconographies hinge on faith. The seemingly dormant cells rest in their crib and possess totipotency—the ability to become more than they appear. The Annunciation is the biblical event when the Archangel Gabriel informs the Virgin Mary she will bear the Son of God. This faith-based act—a virgin birth—further comments on the seemingly unlimited potential of stem cells in human creation. The nature of faith in all its religious and scientific manifestations—questioning and unquestioning—is the subtle dialogue created by Orta's and Girolamo's works.

Orta's choice of materials, setting, colors, and juxtaposition are not accidental. Research into the role of stem cells in human biology, particularly the exponential rise of knowledge in the last decade, means the artists have acquired new areas of insight into how humanity is shaped by the forces of biology. The artists' new authorial direction takes a similar path to cell creativity. Stem cells have always had the capability to diversify and acquire functionality quite apart from their point of origin. Similarly Orta's practice conflates expected outcomes. Just as science continues to unlock the mechanisms of stem cell potential, Orta apply the structure of stem cell creativity to their synthesis of organic structures and architecture.

The fundament of our knowledge of how human life is created is unshakeable. The limits of architectural form and functionality are finite. Or are they? Conception occurs when sperm fertilizes

oocyte and creates a single totipotent cell. A cell with unlimited capability. A superior cell, capable of creating another life. But our faith is shaken. What was once an immutable textbook definition of human life is no longer 100% accurate. Science is redrafting the "map" by which we understand how cells seek to fulfill their biological potential. Just as the Peters projection (1974) exposed the Mercator map's (1569) proportional (and political) inequalities between continents, our remap of cell potentiality reveals, rather than creates, new opportunities. Scientists have created egg cells from stem cells with the developmental potential of becoming embryos without the need for sperm. Taking these totipotent cells as a theme and the seemingly unlimited capability of stem cells as inspiration, it now becomes apparent why Orta's glass cells are colorless. It also becomes apparent how they comment on the micro architecture of the social body, and why our beliefs—religious, scientific, secular, or a combination of points within this trinity—must be constantly re-examined, tested, and expanded.

With a substantial body of work exhibited internationally over the last fifteen years, Orta's most recognizable installations create architectures of people, materials, forms, and shapes that respond to crises of global, but particularly urban, existence. In 2004 Berlin-based architects LIN won an international competition to design the Cité du Design in Saint-Etienne, France, as an institution for communication, diffusion, research, and education in the field of design. Orta was commissioned to create membranes of mobility for the Platine, the 200-meter-long, "free-floating" mono-space that houses communication activities, retail, incubator spaces, and lecture theaters. Conceived by the architects as a three-dimensional surface with a variable skin that adapts as necessary, the Platine is the perfect "shell" for modular units utilizing Orta's enabled "social skins." The "onion layers" Orta referenced in previous work—self, skin, shirt, jacket, sleeping bag, tent, container, etc.—can be adapted for architectural cellular mobility and enhanced

with elements from stem cell technology. Placing cells within the Platine "organism"—a whole with interdependent parts—also references their past work with cellular textiles (e.g. open-cell polyurethane used in *Connector Mobile Village I & II*).

Writers who survey Orta's practice have dug deep and ranged wide to find comparisons of style, composition, and meaning for their work. Artists vary from a peer generation engaged with social issues (Atelier Van Lieshout, Tobias Rehberger, Andrea Zittel, Jorge Pardo) to those in previous generations (Lygia Clark, Nam June Paik, Fluxus, Joseph Beuys, Nouveaux Réalistes). Perhaps because Orta's work defies easy classification, not all these comparisons satisfy. Some appear labored, and a few possess such strong formal differences as to invite the suggestion they have been shoe horned into the argument. Despite his acute observations on the occupation of bodily space, the philosophical views of Martin Heidegger seem antithetical to Orta's practice, in particular their opposition to loss of cultural identity and the growing numbers disenfranchised from society. If we wish to compare Orta's devotional awareness to the causes of social exclusion, isolation, dislocation, and deprivation, then we must expand beyond contemporary artists and philosophers and look to the work of activists, particularly those who work with space.

Although Orta insist their work is not political, the objectives of their practice place them in the company of historian Arno Peters (1916–2002), who (like Orta) created a political climate through his work without labeling himself an activist. Sixty years ago he realized written histories emphasized Europe and North America at the expense of Africa, Asia, and South America. Outraged by the injustice and aware that histories determine contemporary social and political outcomes, he published *Synchromptic World History*, which weighted each country, and each country's history, on equitable scales. He went on to redraw the world map as a visualization of this text. Called the Peters projection map, it was endorsed by the

UN, adopted by countless aid agencies, and sold over 83 million copies. The key to the global currency of Peters' ideas was that he *visualized* his beliefs (adherents include Edward Tufte and his groundbreaking *Visual Display of Quantitative Information*). Orta's response to the same issues and their ability to visualize thinking regarding global inequalities is what links the work of Peters and Orta, and provides the economic, political, and visual foundation for Orta's work.

Cells are factories. They process information, build proteins, and move materials back and forth across their membranes by using complex molecular structures with coordinated moving "machinery." Totipotent cells have total potential. They specialize and create pluripotent cells, which in turn further specialize and create multipotent cells with specialized functionality. As with their practice to date, Orta's current work, particularly the designs for the Cité du Design, borrow from this cellular "total potential." By continuing to take inspiration from the human body, particularly the interior landscape, Orta creates an entirely new architectural response—modular machinery—in which we can inhabit the future.

—  
1. William Cullen Bryant, "Among the Trees," *Putnam's Magazine* (January 1869).

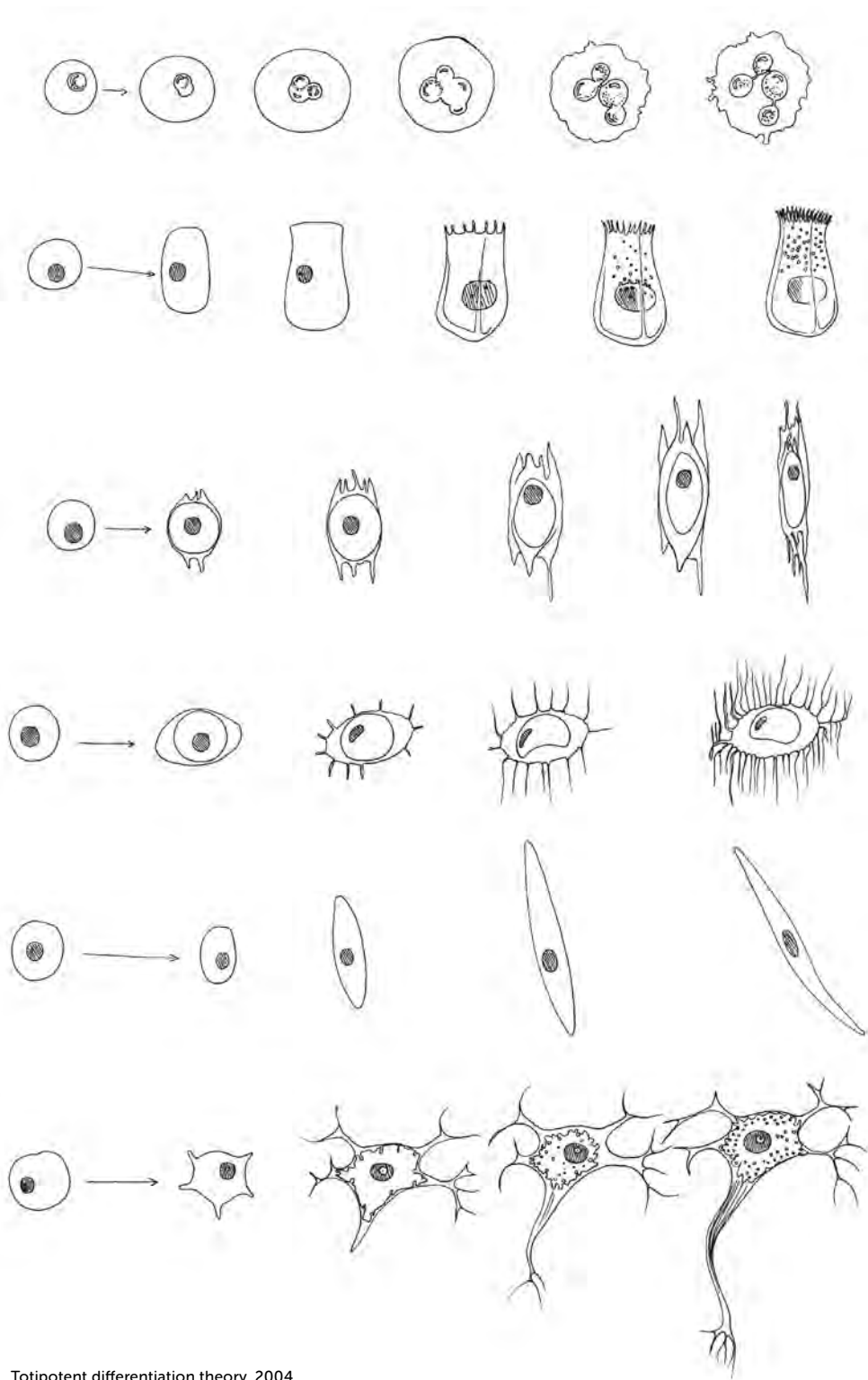

Totipotent differentiation theory, 2004  
Sketchbook drawings

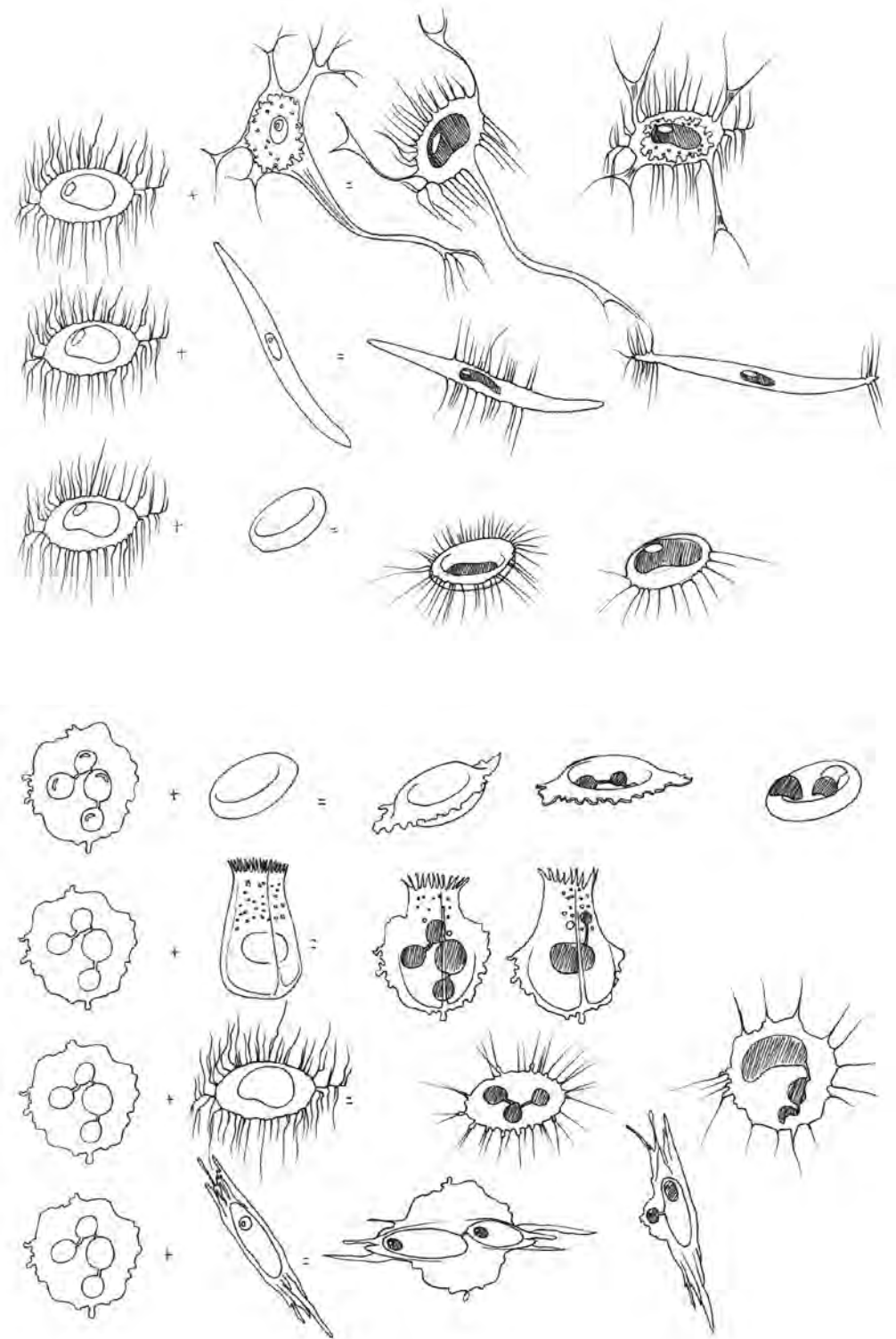

Totipotent communication theory, 2004  
Sketchbook drawings

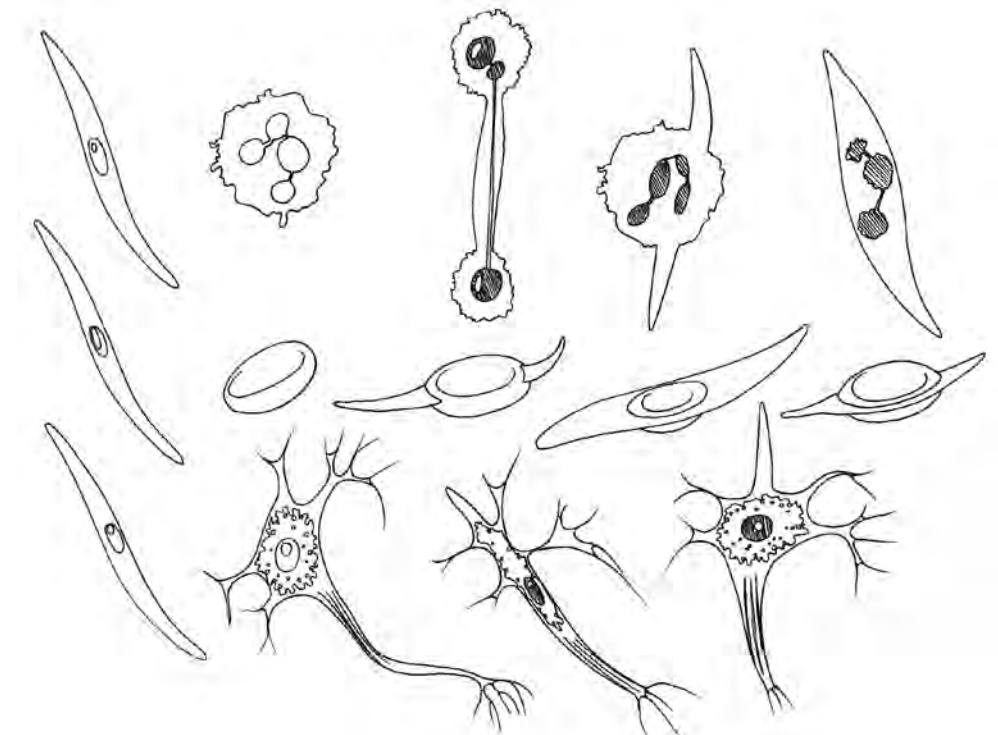
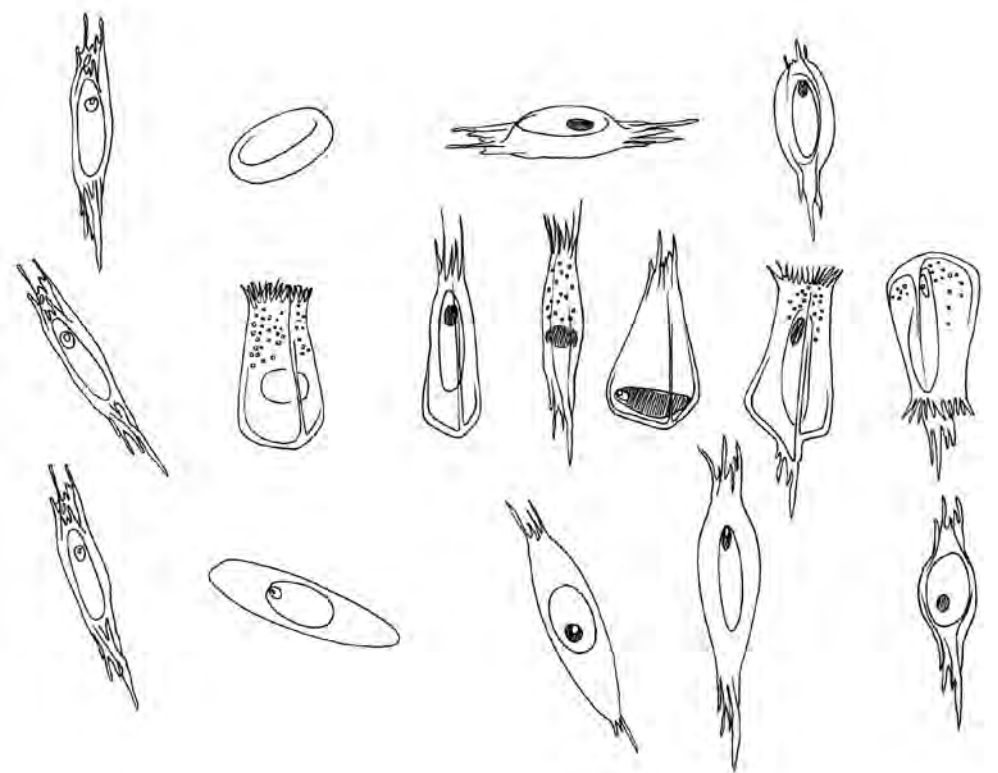
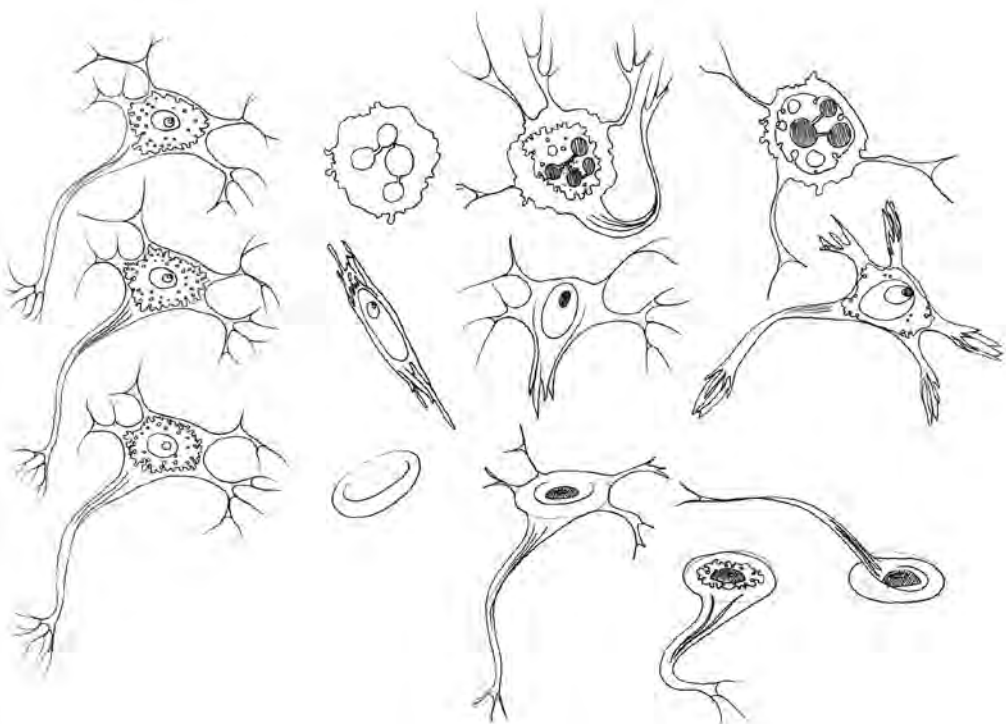
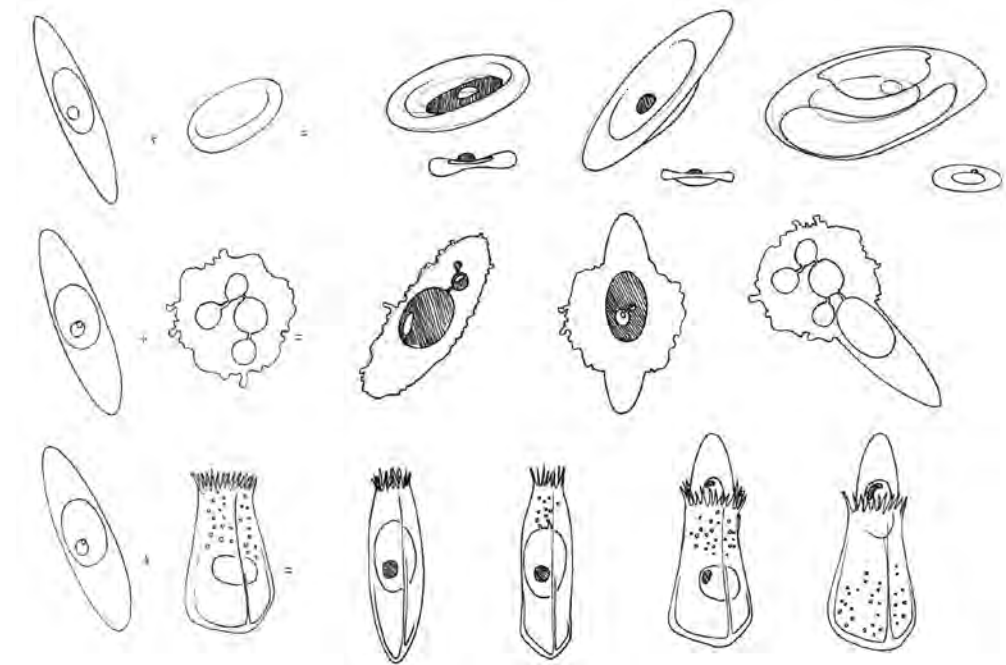

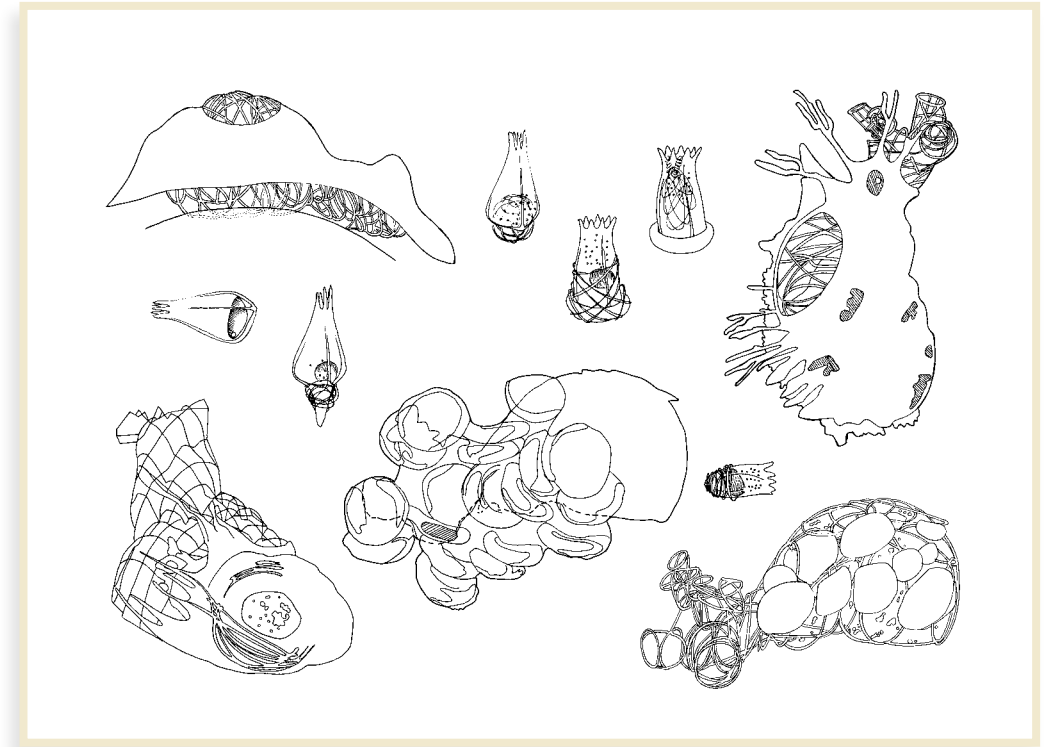
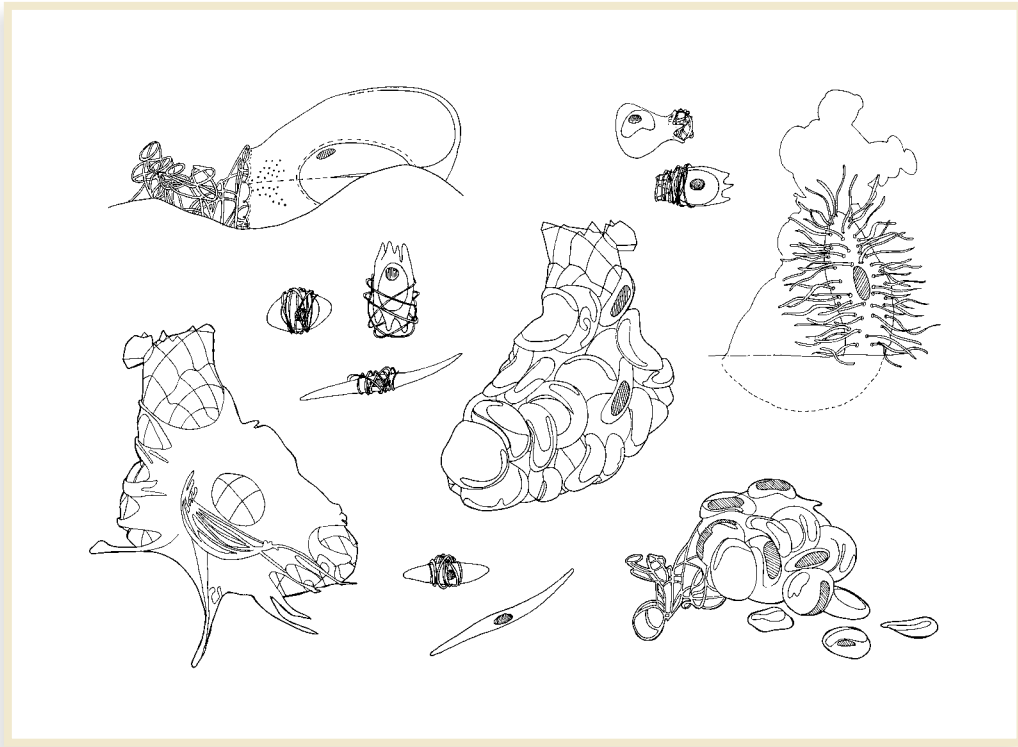

*(left & right)*  
**Totipotent Architecture - Ethereal Bodies, 2004**  
Silkscreen print, ed 150  
92.5 x 4 x 72.5cm (box framed)



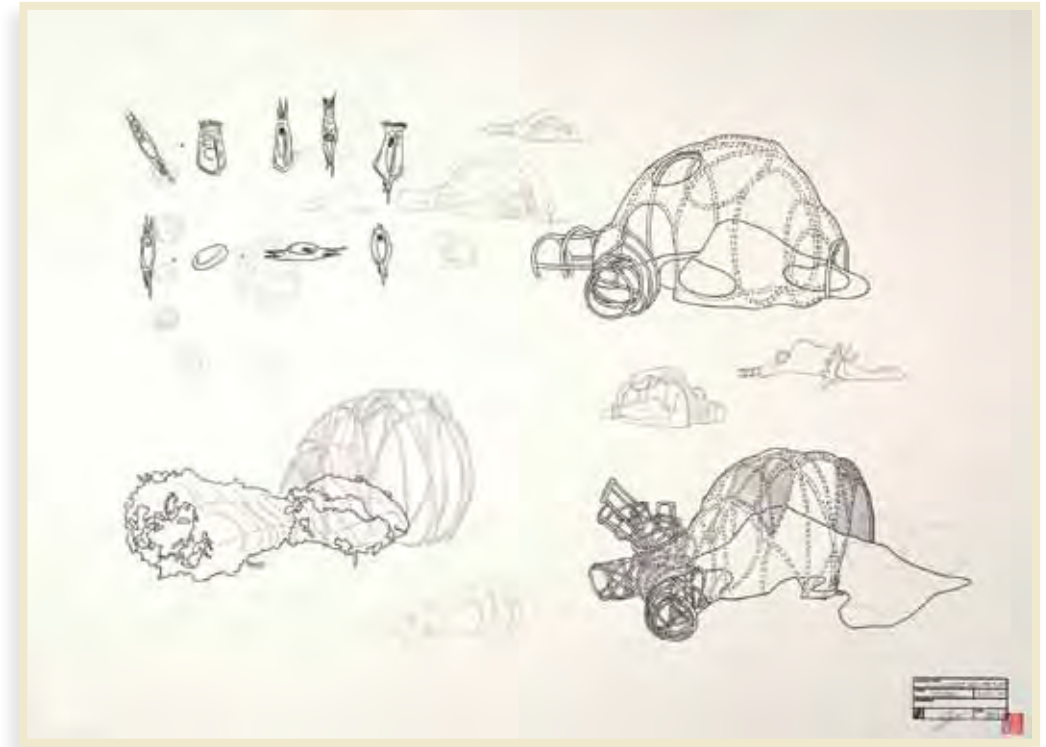

(left & right)  
**Totipotent Architecture - Gazebo, 2007**  
 Pencil, pigment ink, water colour on Fabriano paper  
 92.5 x 4 x 72.5cm (box framed)

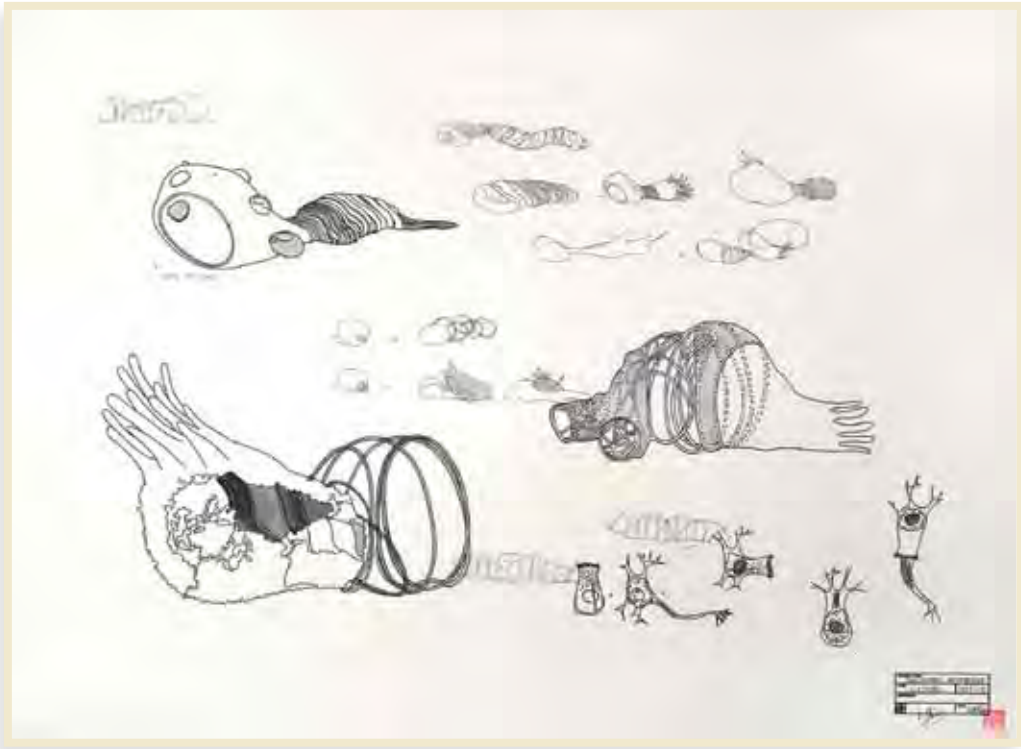

(left & right)  
**Totipotent Architecture - Gazebo, 2007**  
Pencil, pigment ink, water colour on Fabriano paper  
92.5 x 4 x 72.5cm (box framed)



---

JAMES PUTNAM

---

Excerpt from  
**The Shape of the Clouds and  
the Shape of Space and Time<sup>1</sup>**

For *Arte all' Arte*, a project in the Tuscan town of Buonconvento, Lucy+Jorge Orta installed a series of specially made sculptures in crystal and steel in the Sacred Art Museum. The works were made in collaboration with local artisans and celebrate Colle di Val d'Elsa's crystal-blowing tradition. *In Vitro* is a modified antique cradle containing organic crystal-blown forms, whose placement juxtaposes a Renaissance painting of the Annunciation by Girolamo di Benvenuto. Orta have also created a series titled *Totipotent Architecture*, presented on metal and glass tables installed along the length of the gallery. These curious constructions consist of cut metal architectural silhouettes and armatures with organic blown-crystal extensions. They include an interactive work where local visitors can write down their secret wishes for the future and insert them in glass test tubes, which they deposit at the base of the sculpture. This is an extraordinary structure, with ladder-like elements and tiers upon which strange, imaginary textile "infants" in hand-crafted bivouacs rest on bunk beds. Like chrysalises hibernating in cells, they relate directly to Orta's *Connector Body Architecture* artwork, suspended from Buonconvento's gateway.

This new series was inspired by Orta's recent research into the microstructure of human cells in their earliest stages—the transformation of the embryonic cell into defined, "architectural" structures, which the artists refer to as "cells of habitation." In the context of Buonconvento, and in juxtaposition to Girolamo's Annunciation painting, these imaginary architectural models express a "vision" or a birth of new architectural forms as organic extensions of the historic Tuscan buildings. Like the *Connector Body Architecture* works climbing the city gates, they symbolize the human biological chain, ever evolving into infinite forms. Both elements of Lucy+Jorge Orta's project become one, reconnecting private thoughts and aspirations with public institutional space that relates to both the community structure and a futuristic vision for the architecture of Buonconvento.

---

1. James Putnam, "The Shape of the Clouds and the Shape of Space and Time," in *Arte all'arte. La forma delle nuvole. Arte, architettura, paesaggio*, eds. James Putnam, Achille Bonito Oliva, and Mario Cristiani (Pistoia: Gli Ori, 2004).

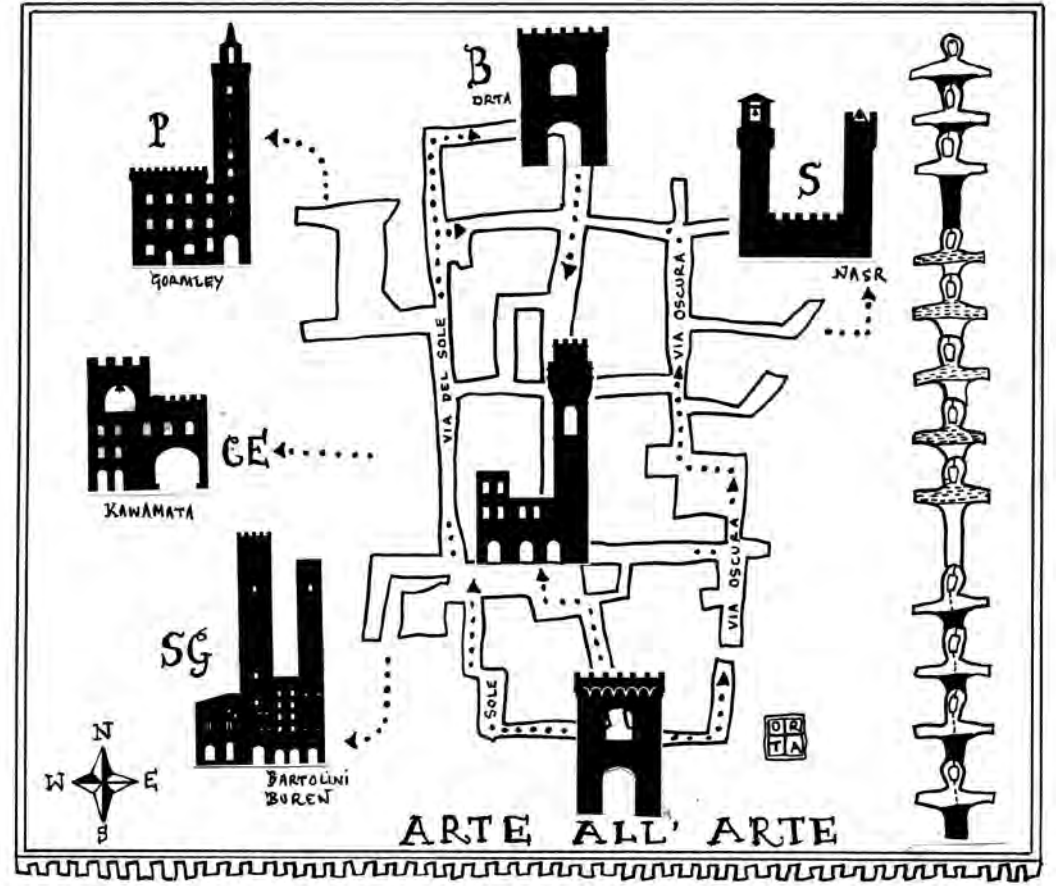

Connector Body Architecture - Buonconvento, 2004

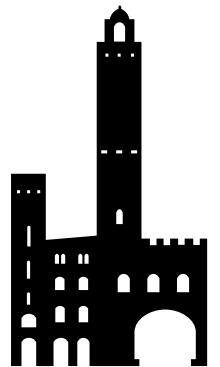
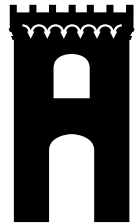
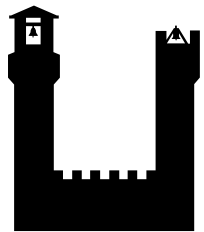
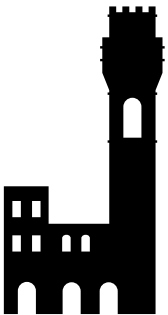

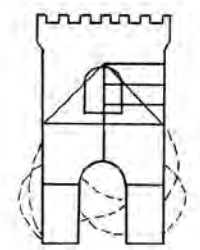
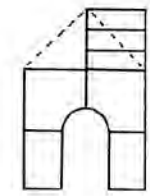
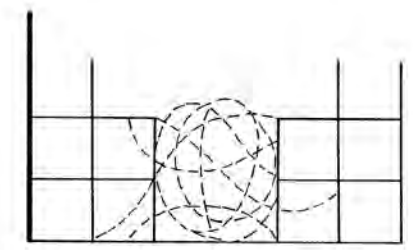
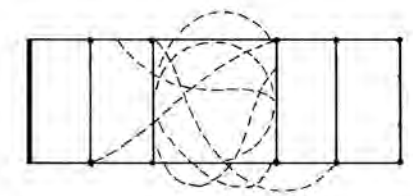
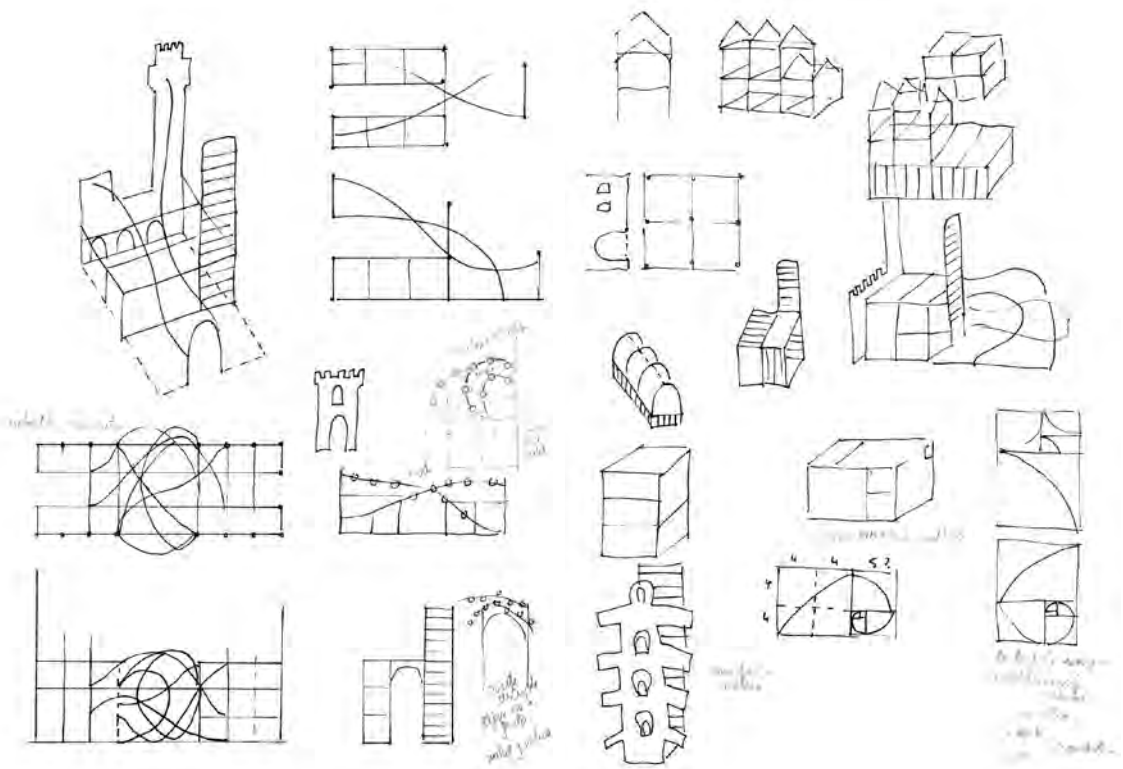

39.15

21

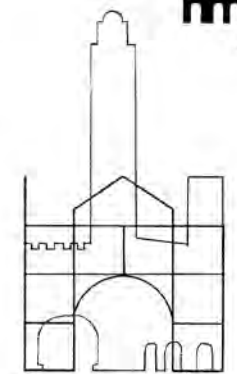
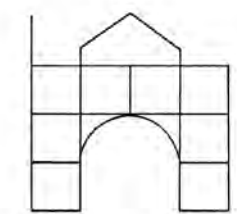
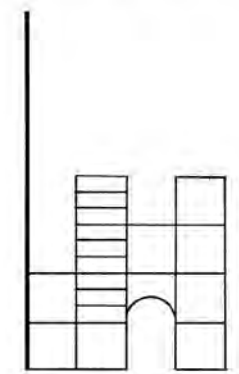
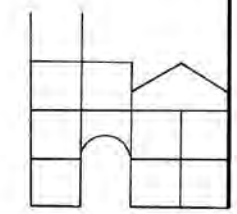
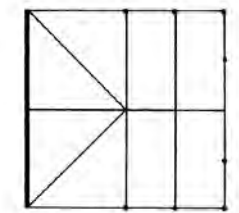
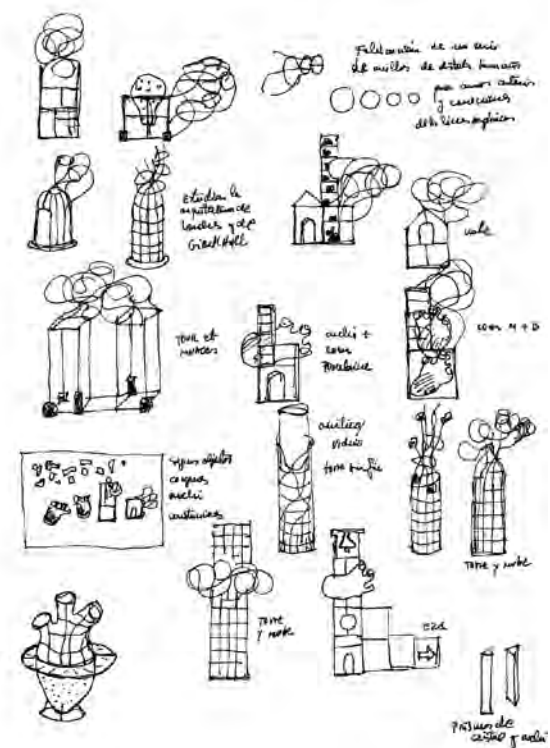
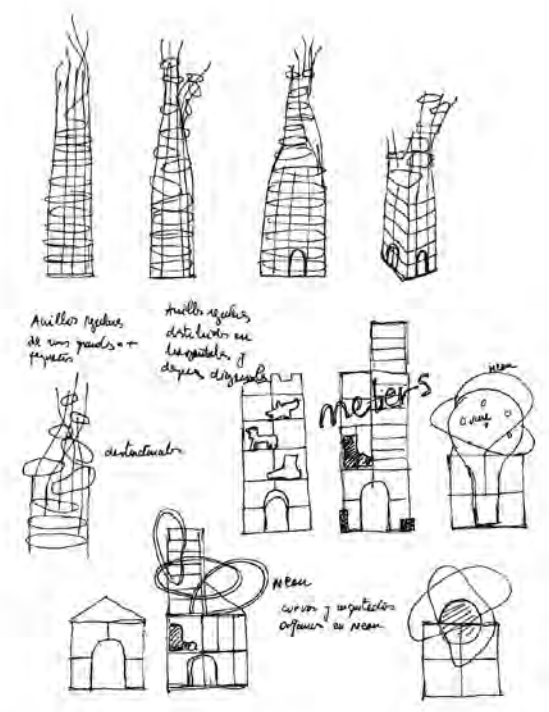

50

24







Totipotent Architecture - In Vitro, 2004





Totipotent Architecture - Tuscany, 2004  
Installation in the Center for Contemporary Visual Arts, Brighton

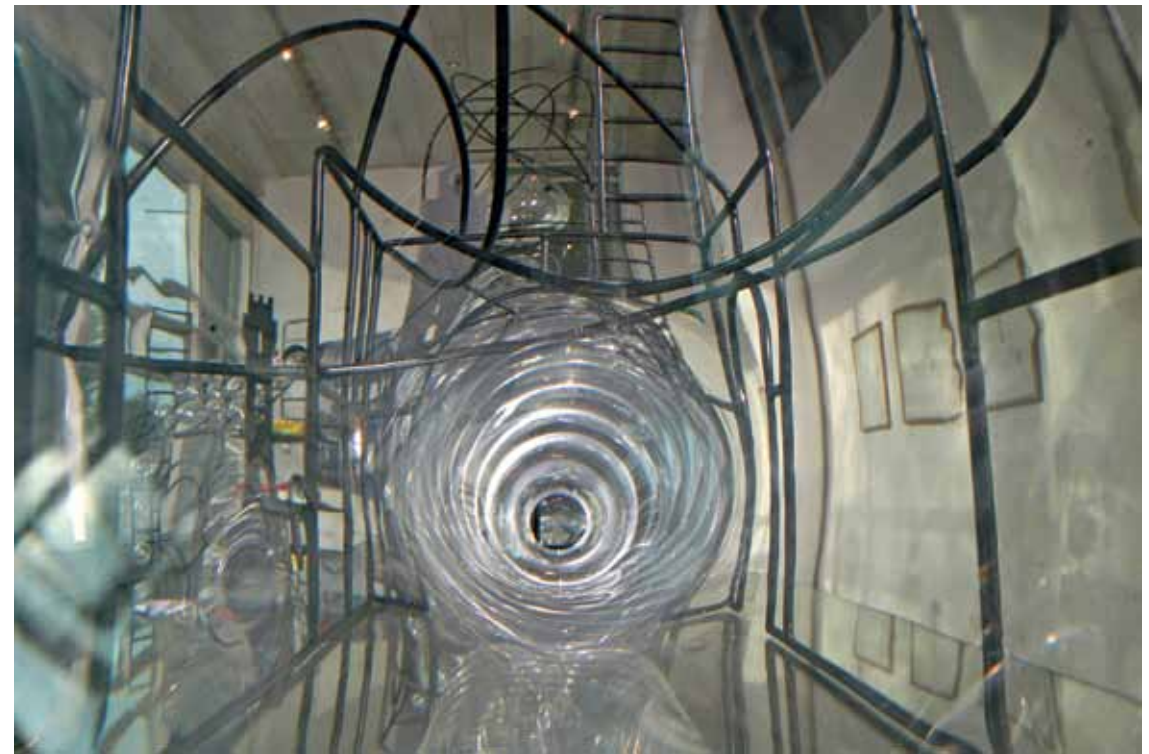

Totipotent Architecture - Tuscany (study), 2004

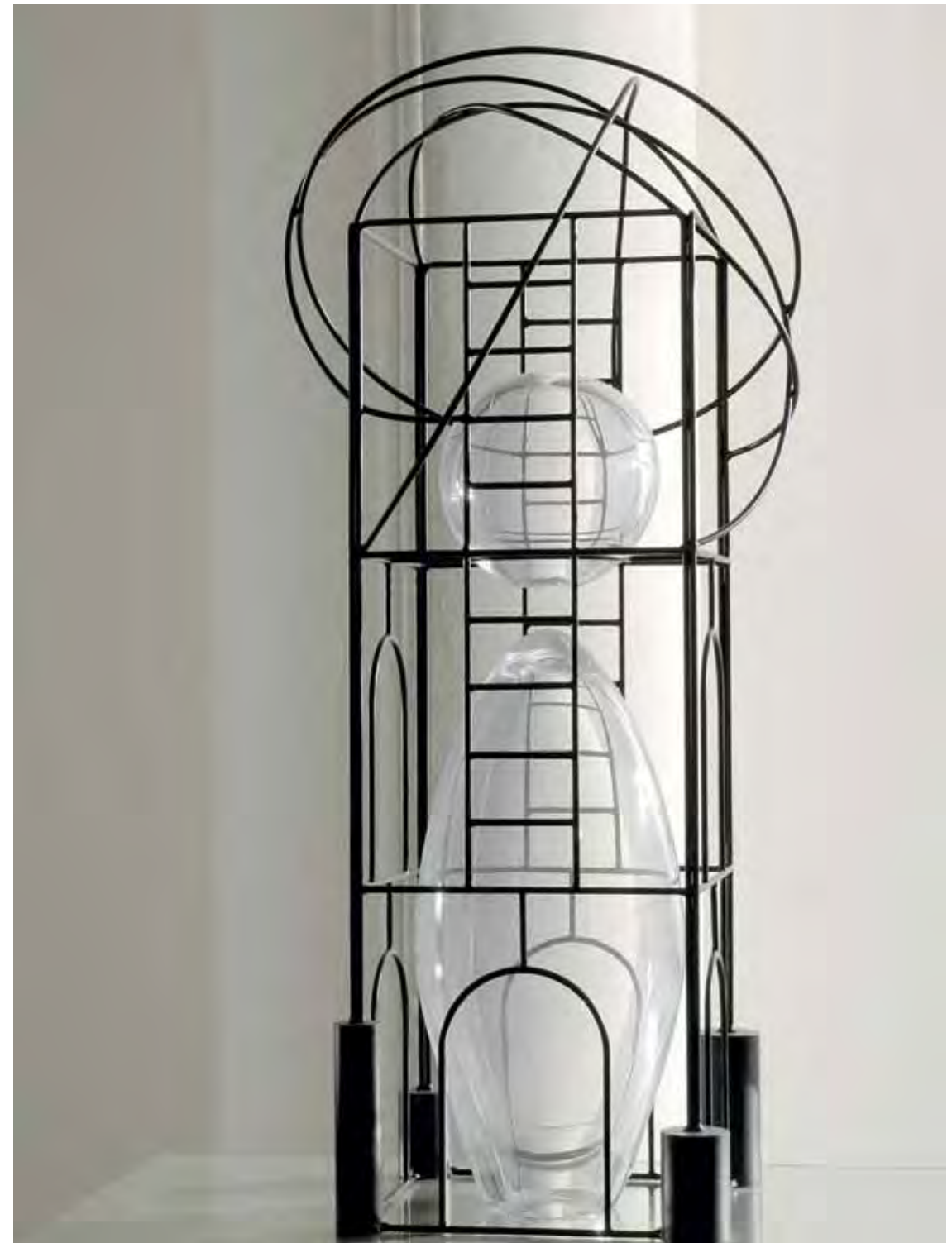

*(left & right)*  
Totipotent Architecture - Tuscany (study), 2004



*(left & right)*  
Totipotent Architecture - Tuscany (study), 2004

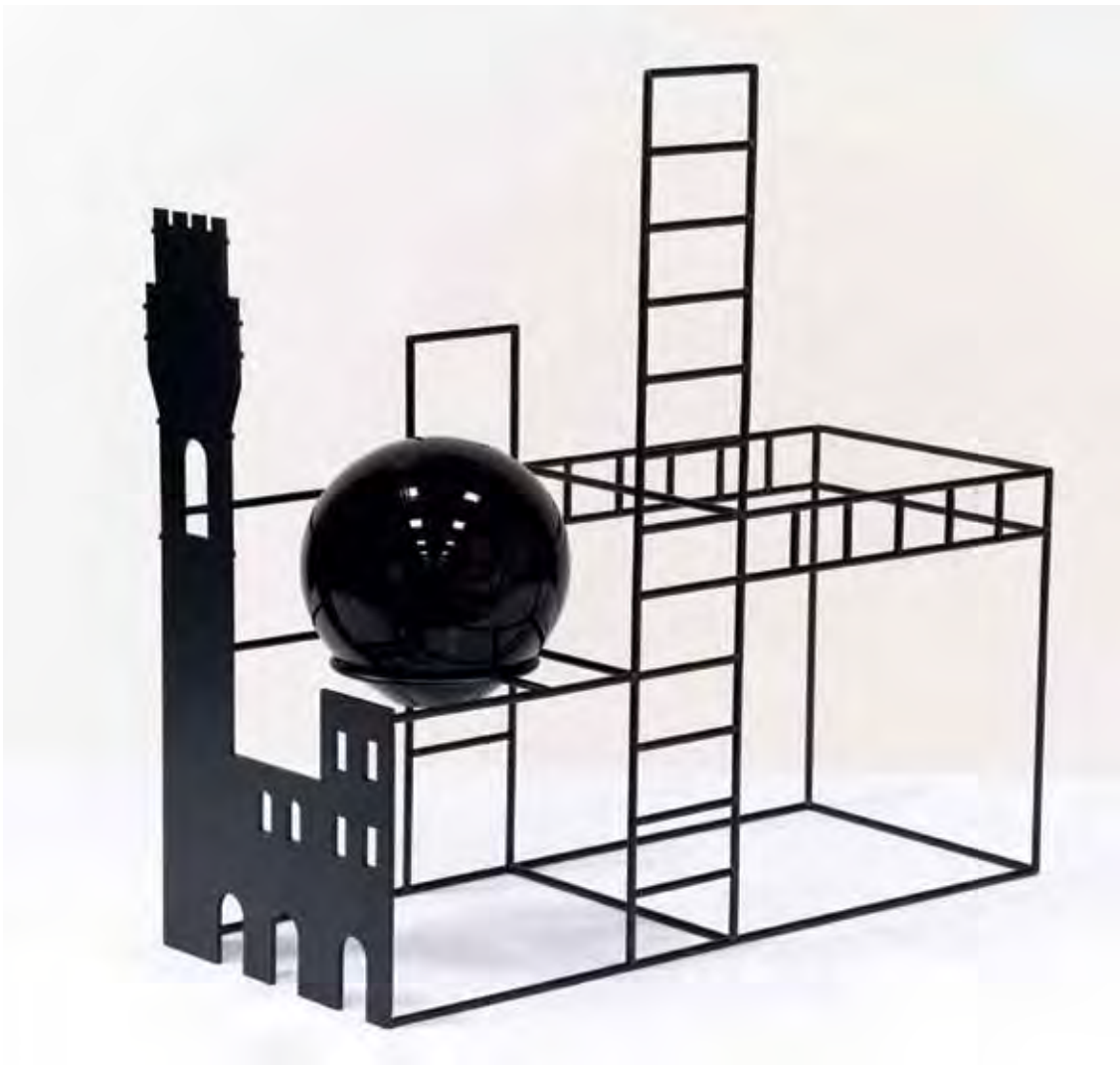

(left)  
Totipotent Architecture - Tuscany (study), 2004-08

(right)  
Totipotent Architecture - Tuscany (study), 2004





Totipotent Architecture - Tower of Dreams, 2004



## Potential Architecture Les Moulins

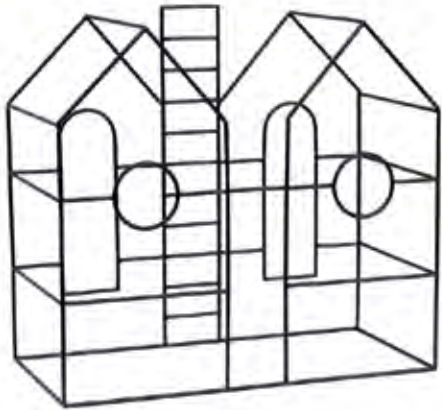

Since they began collaborating in 1992, Lucy + Jorge Orta have been working toward their most ambitious endeavor yet: a monumental, permanent center dedicated to environmental preservation, artistic experimentation, and scholarly research. Called Studio Orta – Les Moulins, the not-for-profit association encompasses three former industrial complexes spanning eight kilometers nestled in the Grand Morin valley outside Paris. Its three sites, Laiterie Saint Simeon, Moulin de Boissy, and Moulin Sainte-Marie, comprise a former dairy and two paper mills. For over a decade the artists have been in the process of rehabilitating these derelict buildings into what they term a cultural village: a nerve center of artistic inquiry and intellectual exploration.

Many of Lucy + Jorge Orta's greatest achievements derive from the smallest of seeds. Their powerful series *Totipotent Architecture*, which explores habitation and identity, was conceived from life's miniscule building blocks: the human stem cell. Orta's work draws frequently from mutable materials and ephemeral structures, such as repurposed textiles, endangered flora, clouds, and light. Their practice, however, remains consistently and insistently concerned with humankind's enduring relationship to its environment and the attainment of a sustainable future.

The property is so vast that Les Moulins' activities are currently centered around Moulin Sainte-Marie, a former paper mill conglomerate dating as far back as the twelfth century. Today the complex houses artwork production, workshops, conferences, and artist residencies, but this is only the beginning. The artists have plans to build a research laboratory focused on art and the environment, a bookshop, and a café.

More recently, this site has become the departure point for Orta's continuing *Totipotent Architecture*



artworks. Steel maquettes carefully reproduce the contours of the former Rives d'Arche paper mill, the electricity turbine hall, the sewage plant reservoirs, and the machinery hangers. These provide the framework for delicate glass shapes that encrust the ambits and fill the volumes of the Moulin Sainte-Marie sculptures. Building structures function as metaphorical stem cells, out of which translucent black spheroids, red fingered orbs, and perfect crystal spheres are born.

The artists' vision for the surrounding land, however, remains firmly planted on soil. Les Moulins' sprawling grounds are refuge to extraordinary biodiversity. In 2009 the region was declared a Natural Regional Park, bringing nature conservation to the fore of

Orta's project. The river, gardens, and woods of the nineteen-hectare association are in the process of becoming home to a vast sculpture park dedicated to the preservation of in-situ works of art.

Les Moulins follows in the footsteps of artist-founded institutions like Donald Judd's Chinati Foundation in Marfa, Texas, and Robert Wilson's Water Mill Center for performance on Long Island, New York, but it is unique in its sensitivity to the site's cultural heritage and its commitment to rethinking social and ecological agendas for the future. Les Moulins may have originated from thoughts on cell biology, but its development more closely echoes that of the human spirit, endlessly yearning, unfolding, renewing.



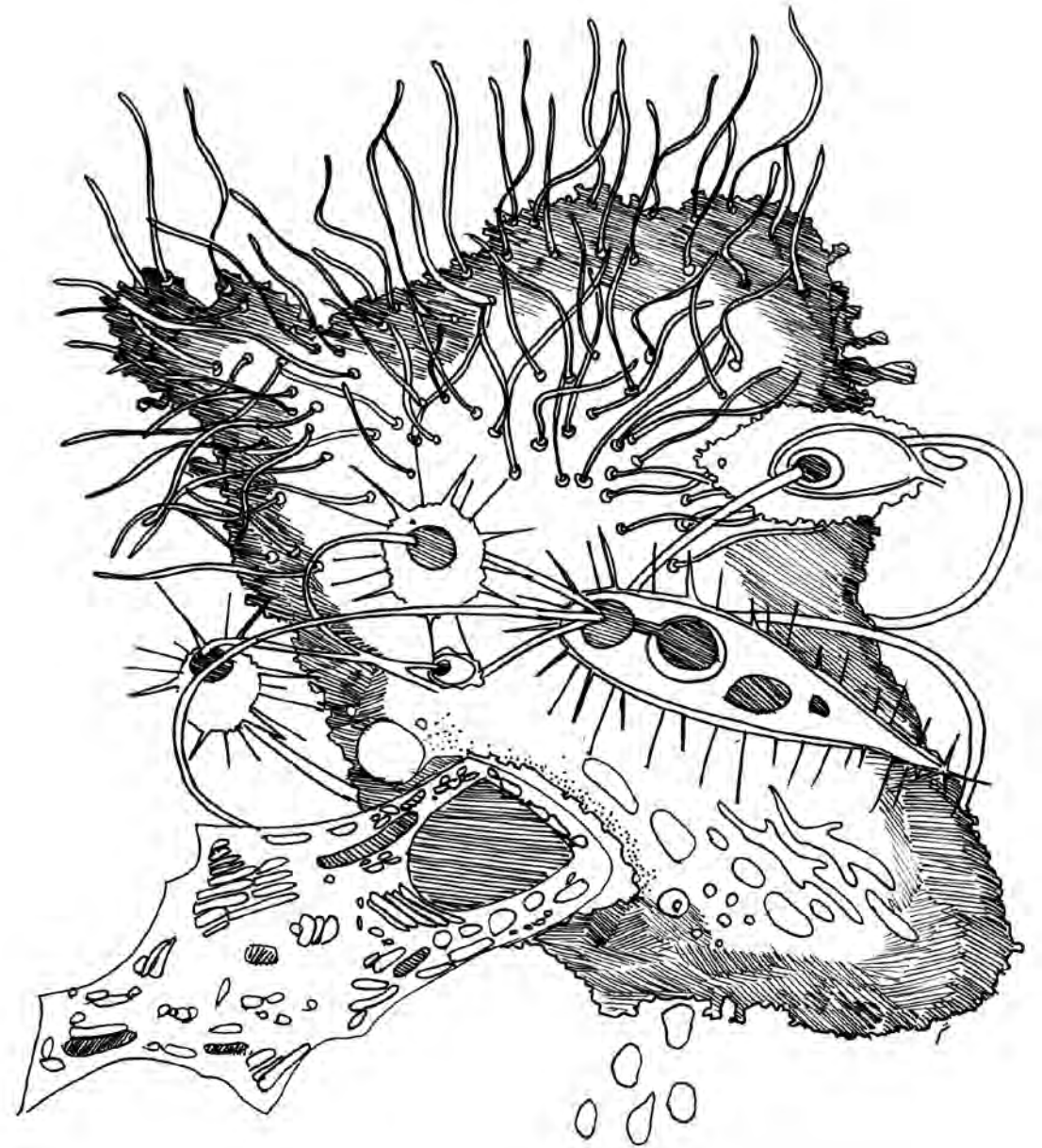
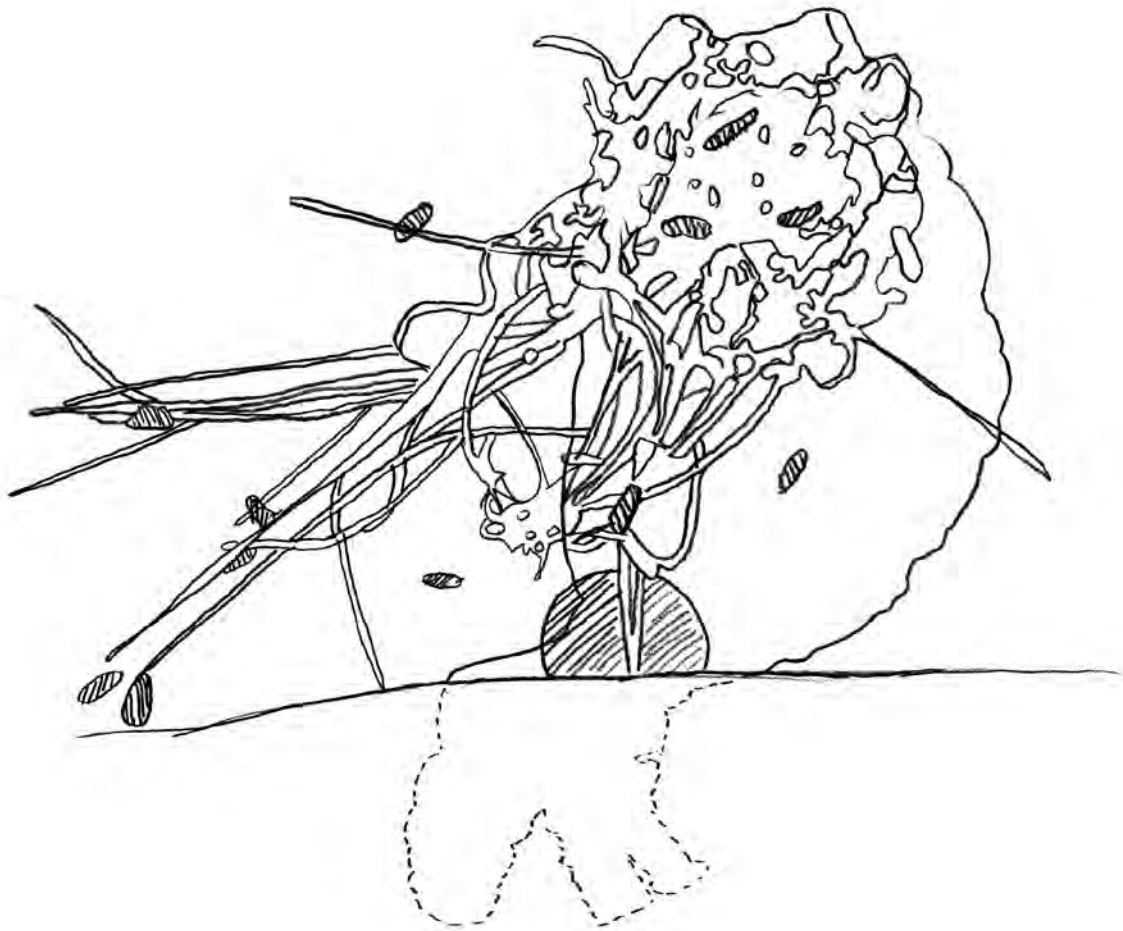

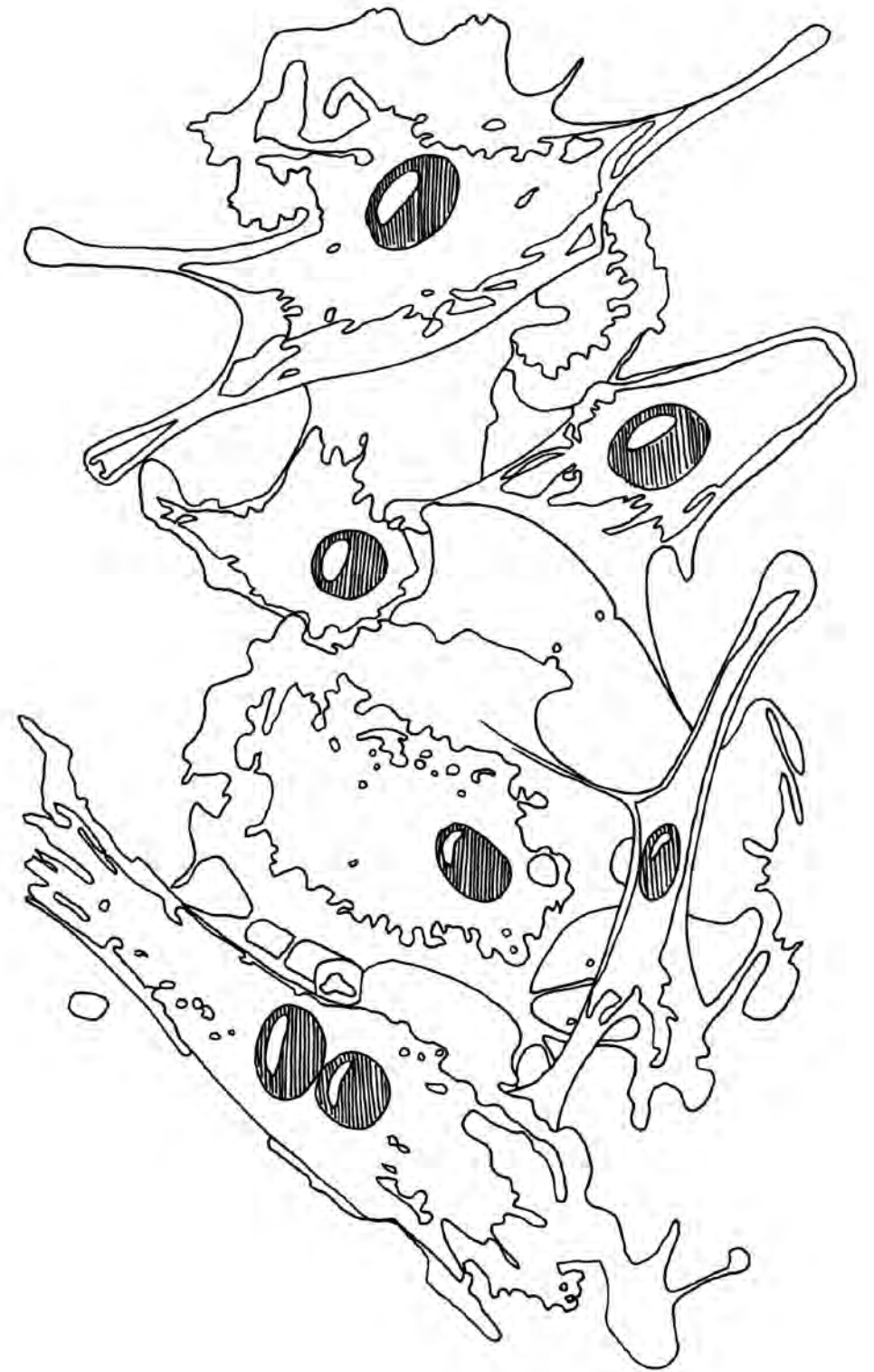
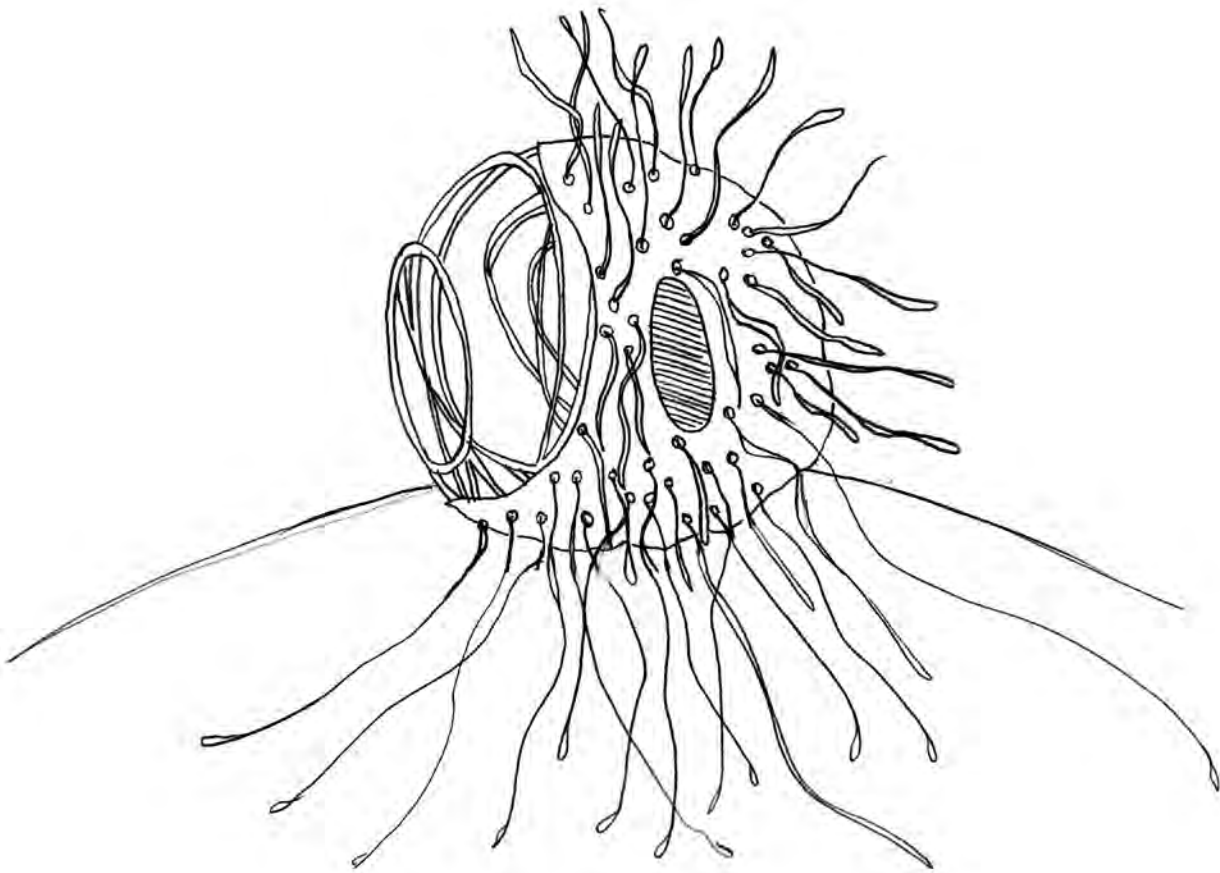

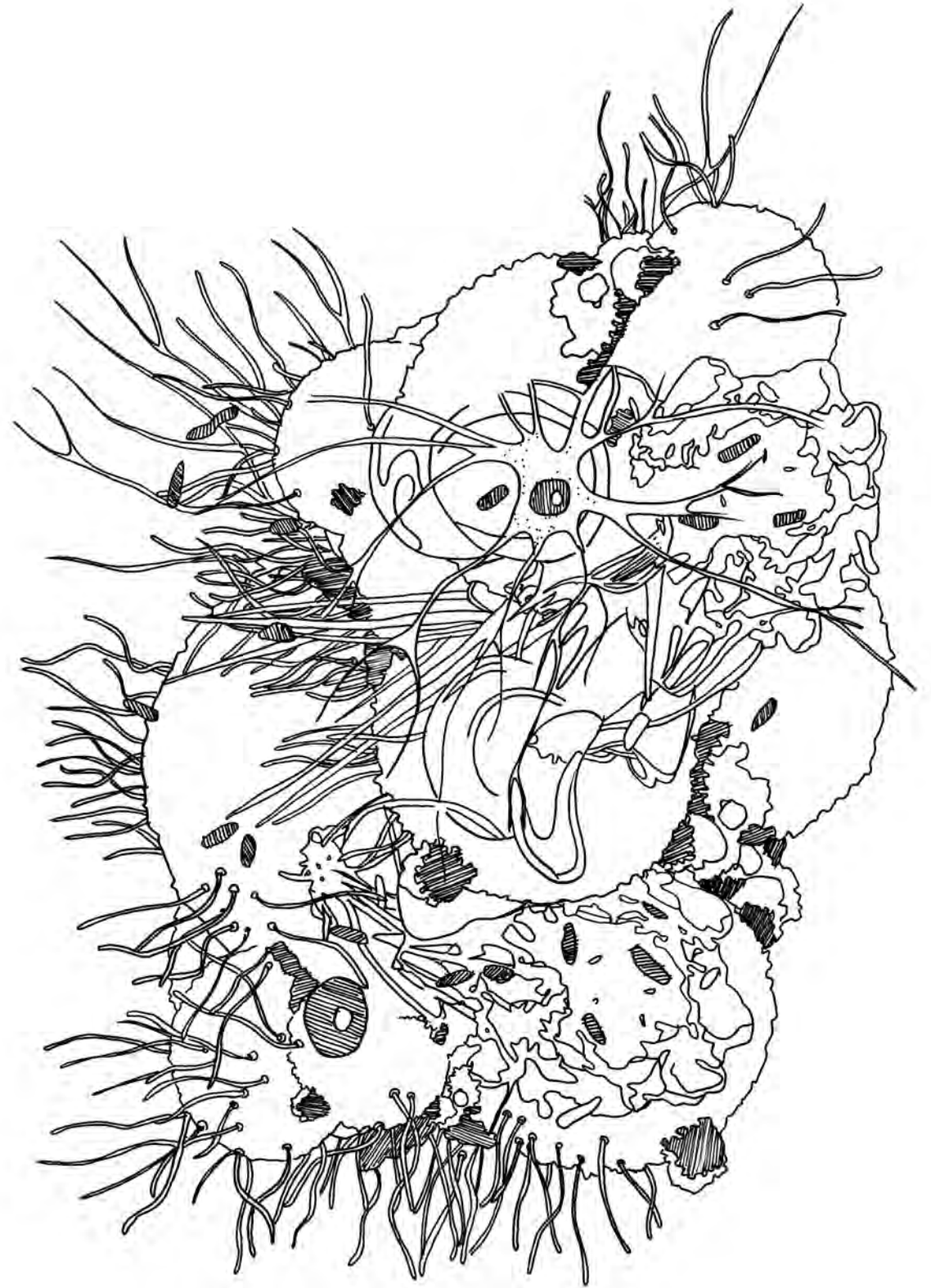
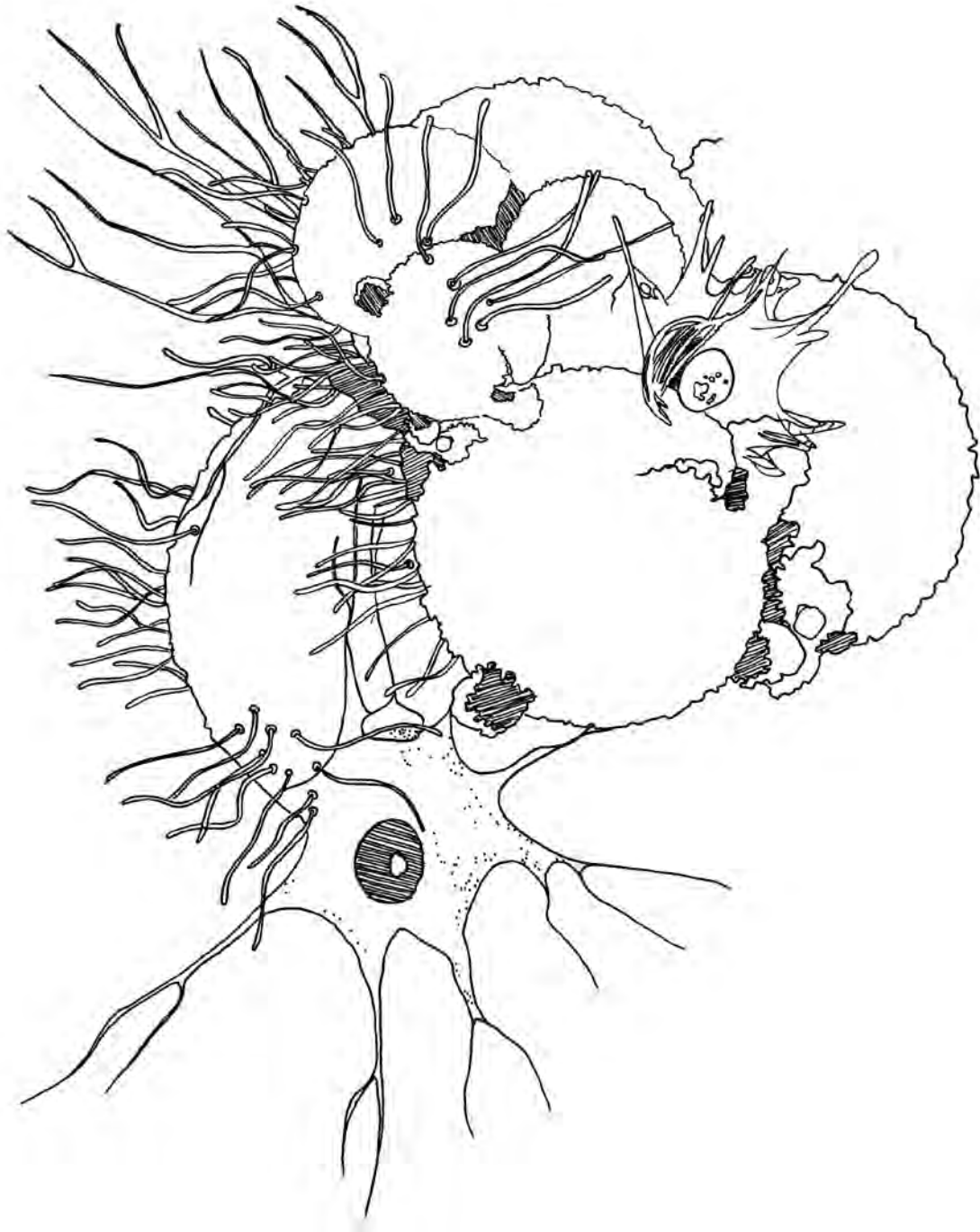

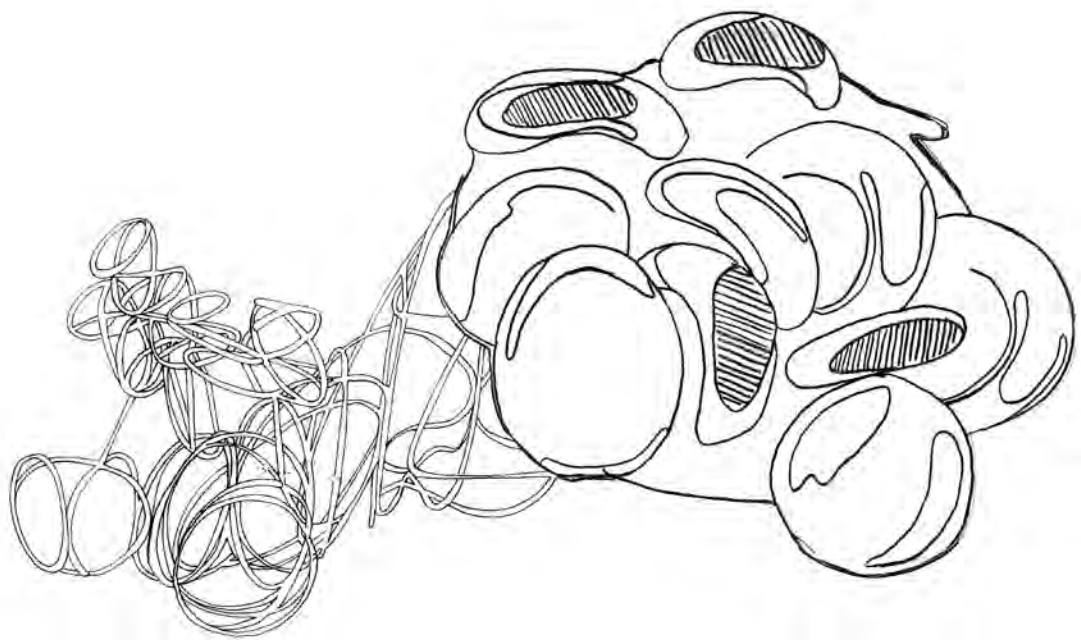

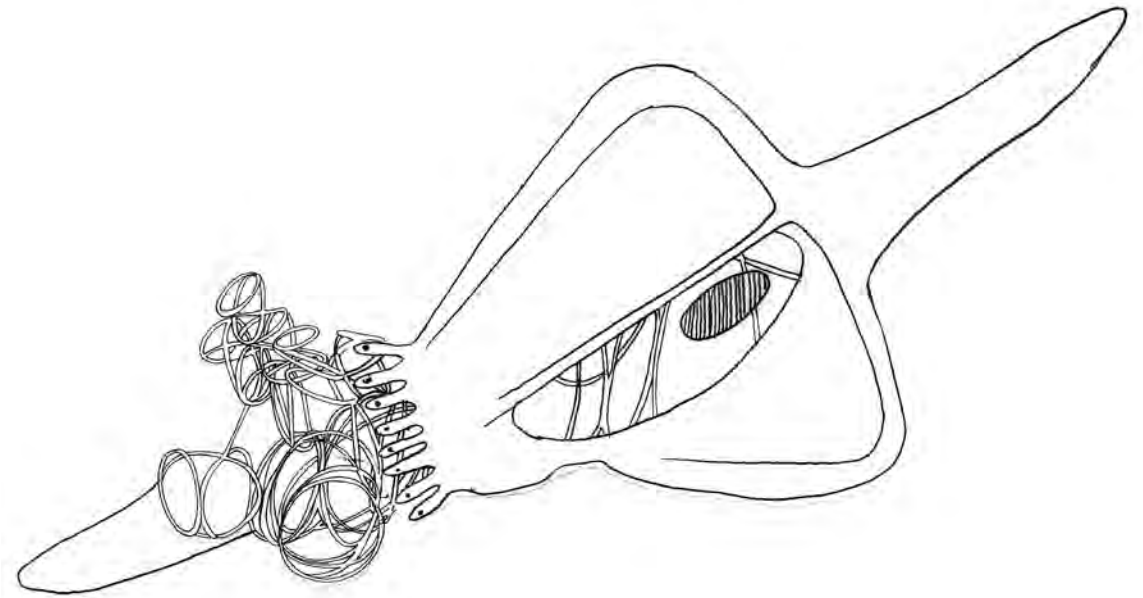
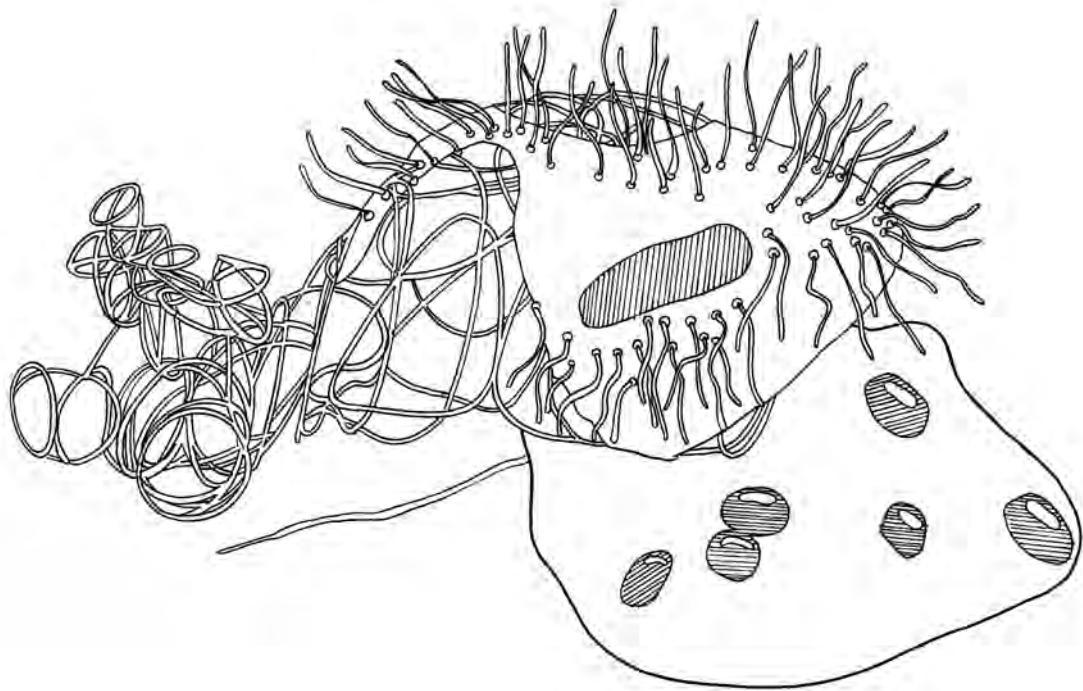

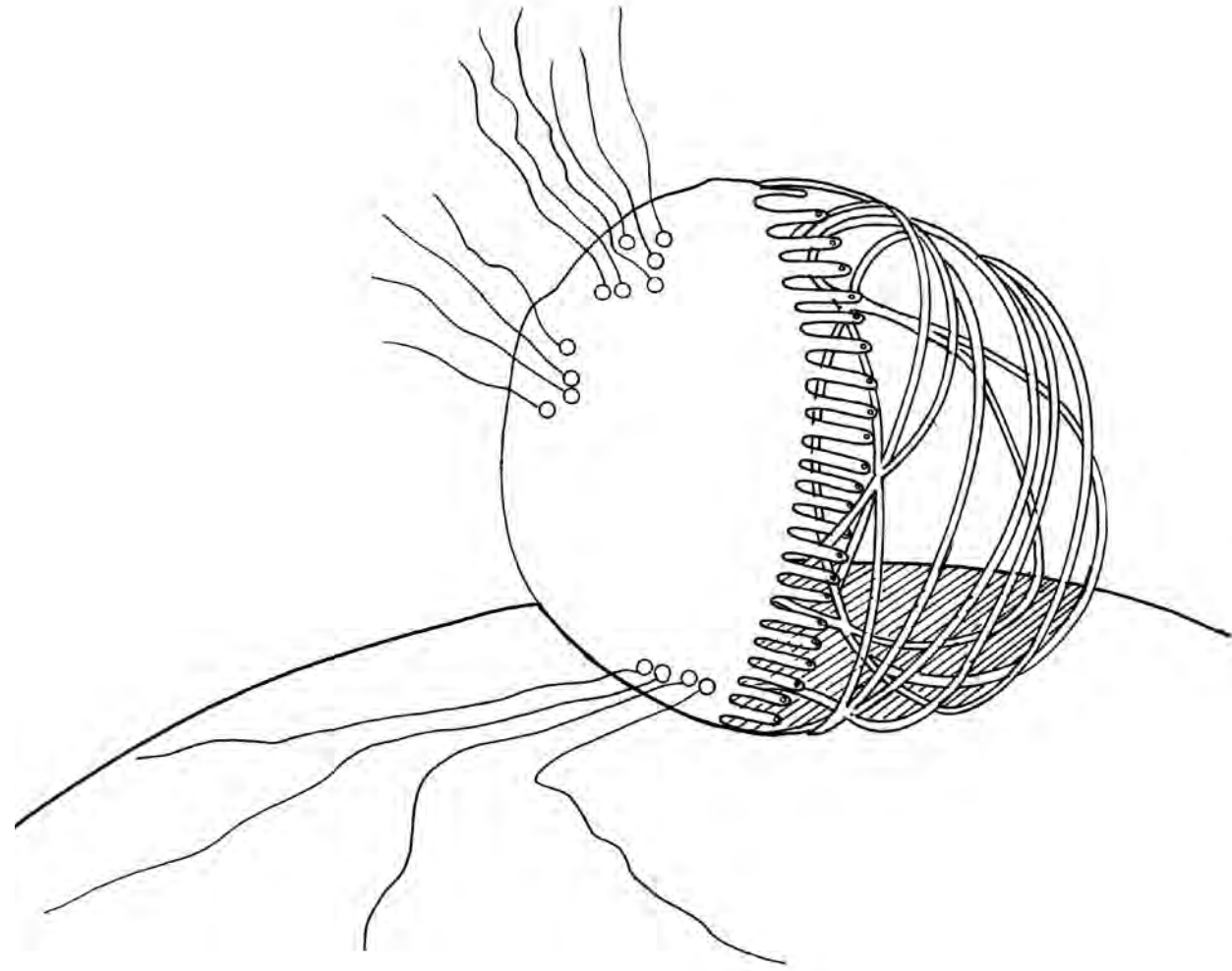
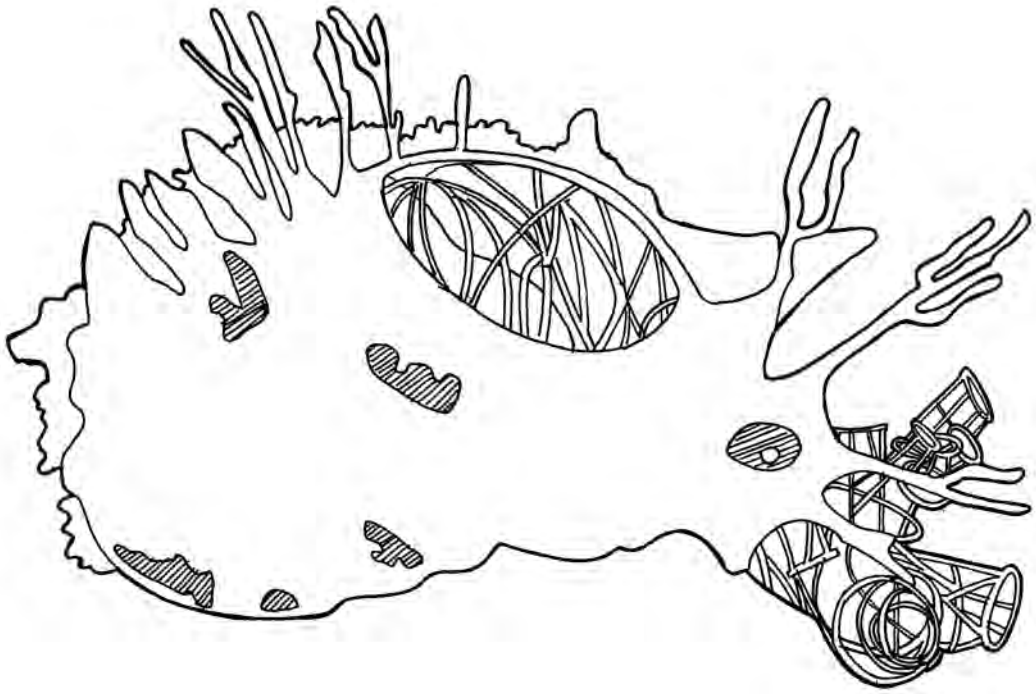

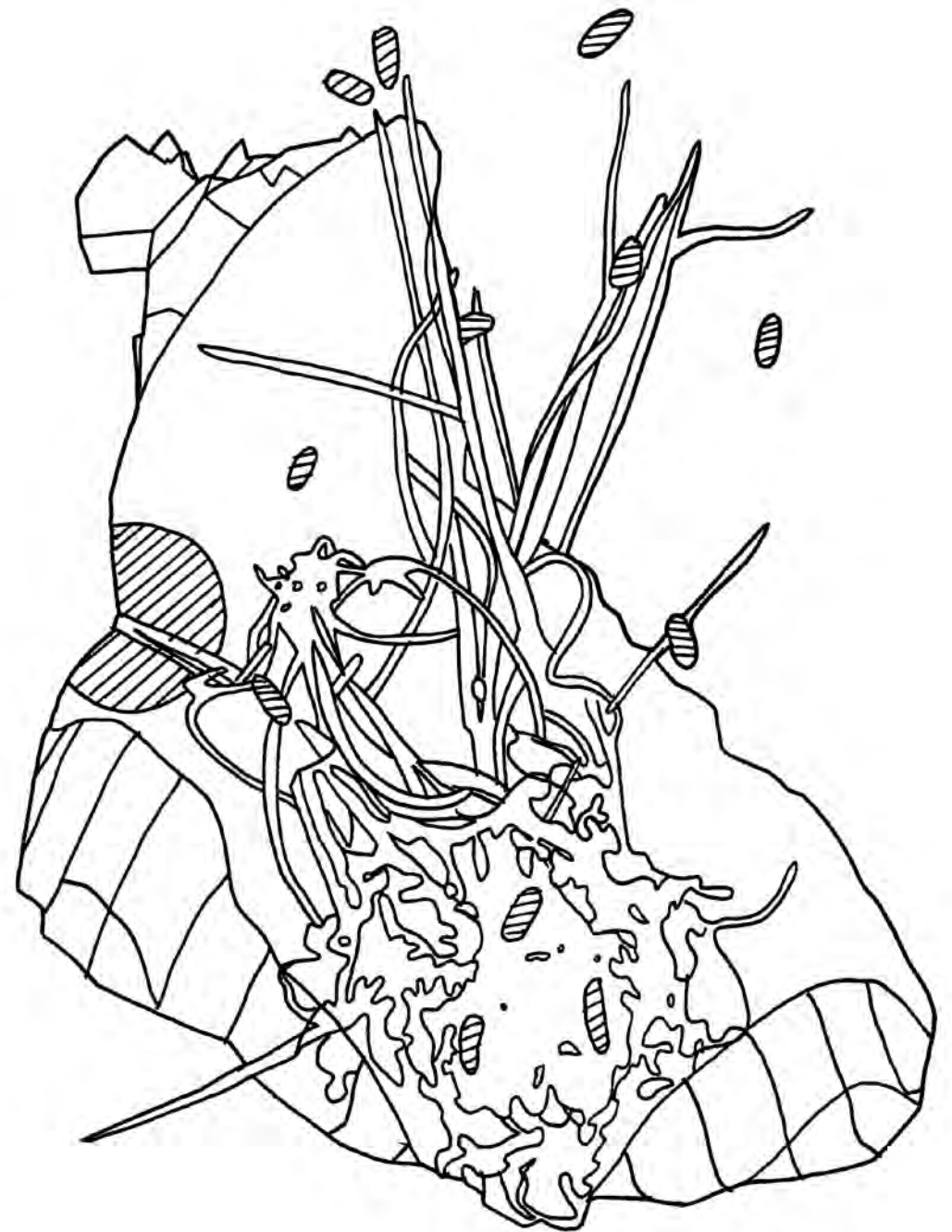
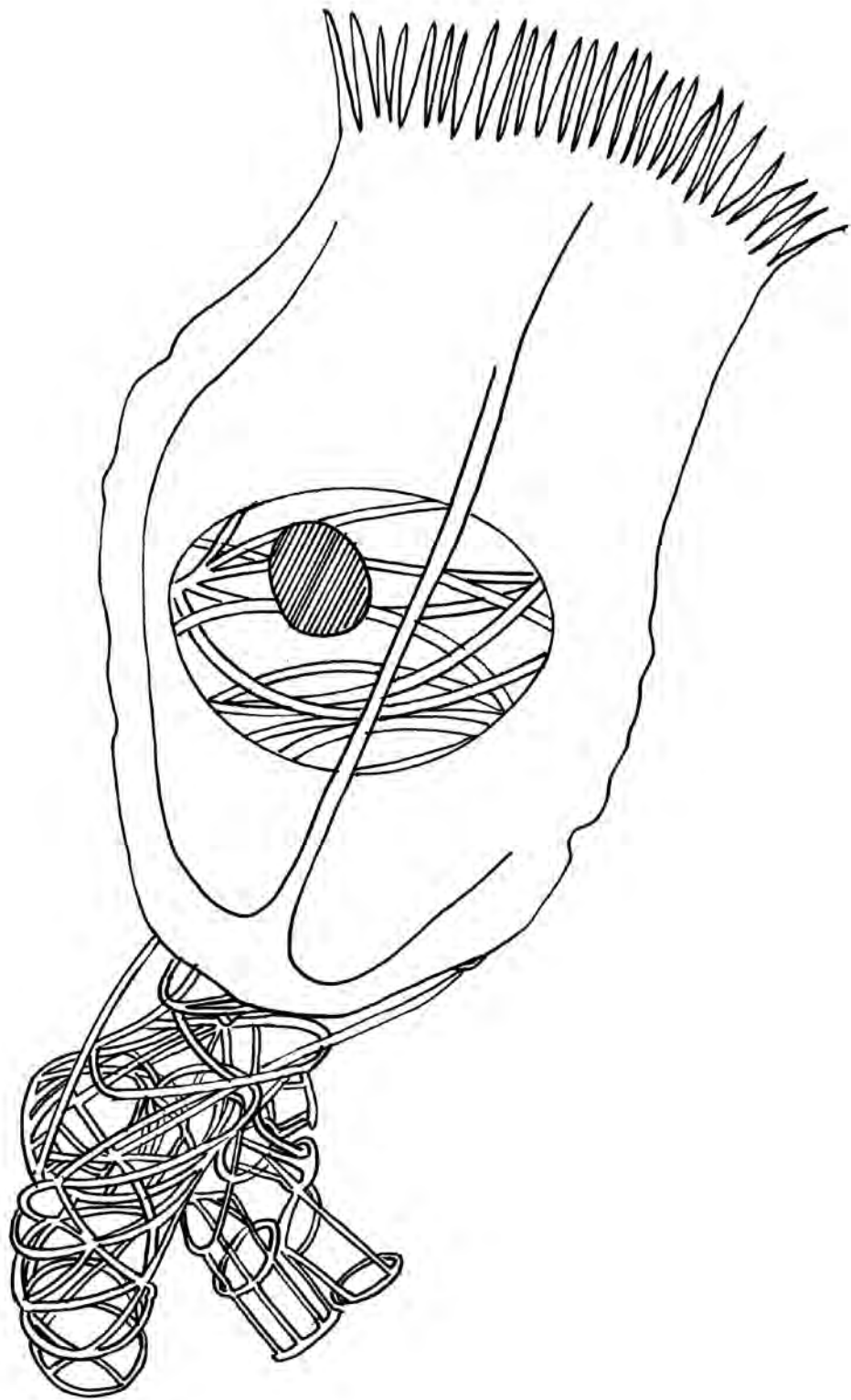

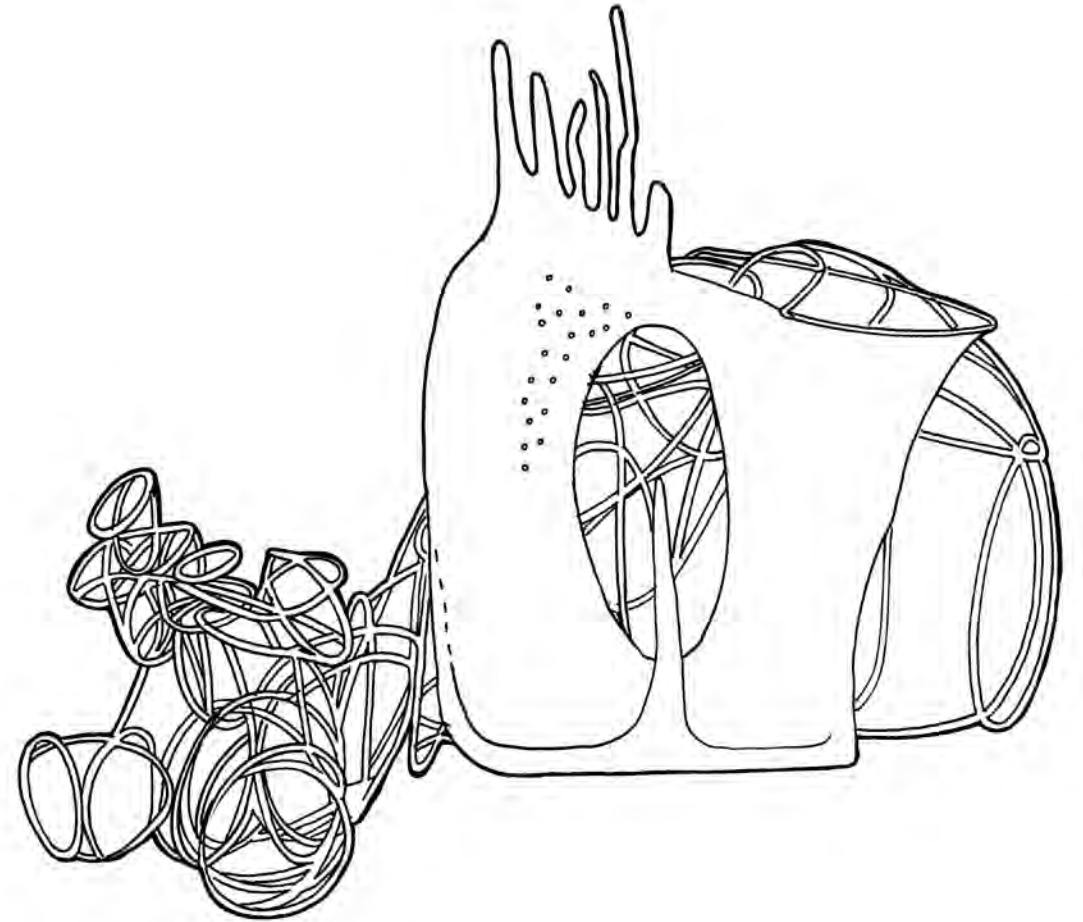
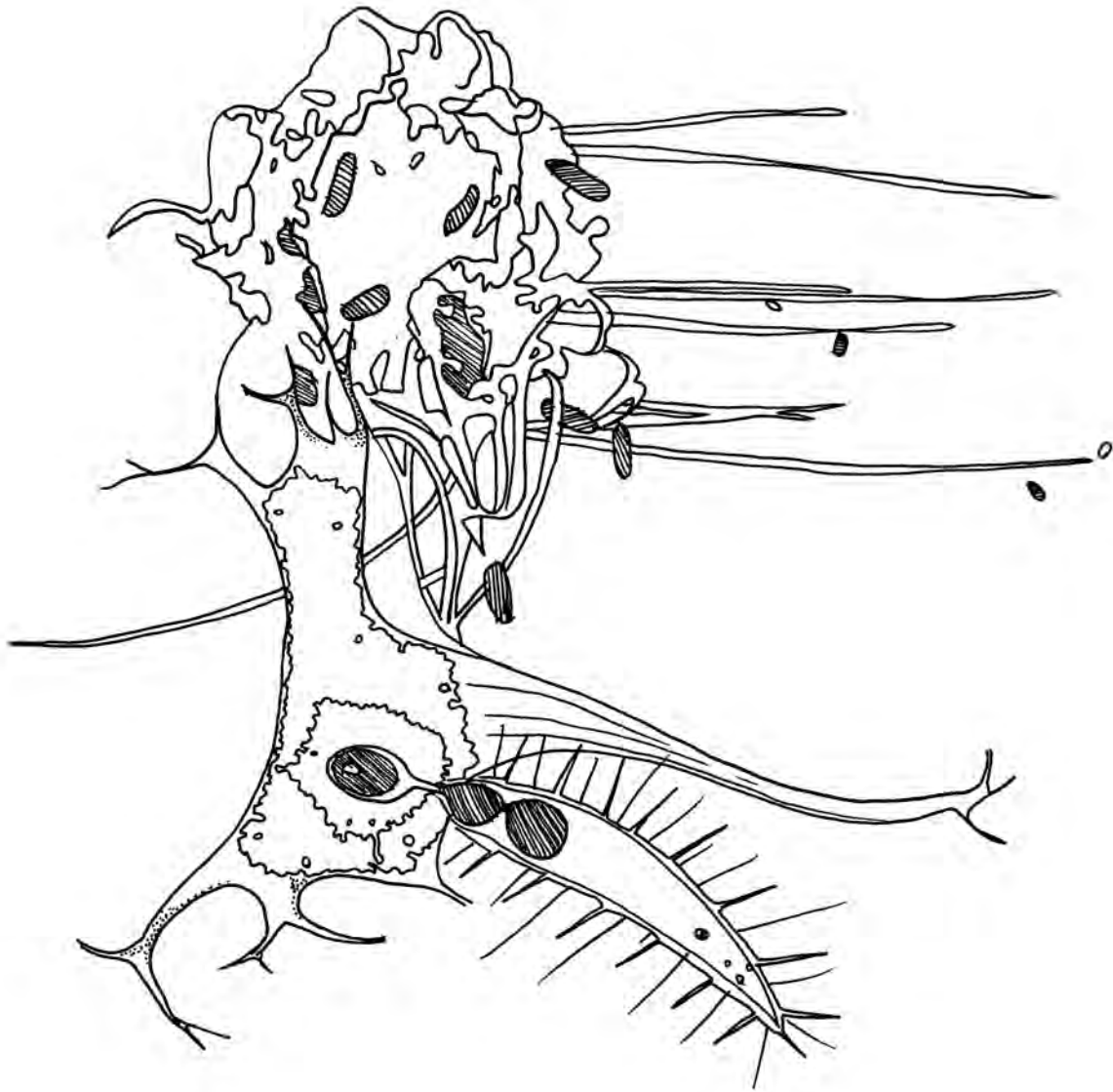



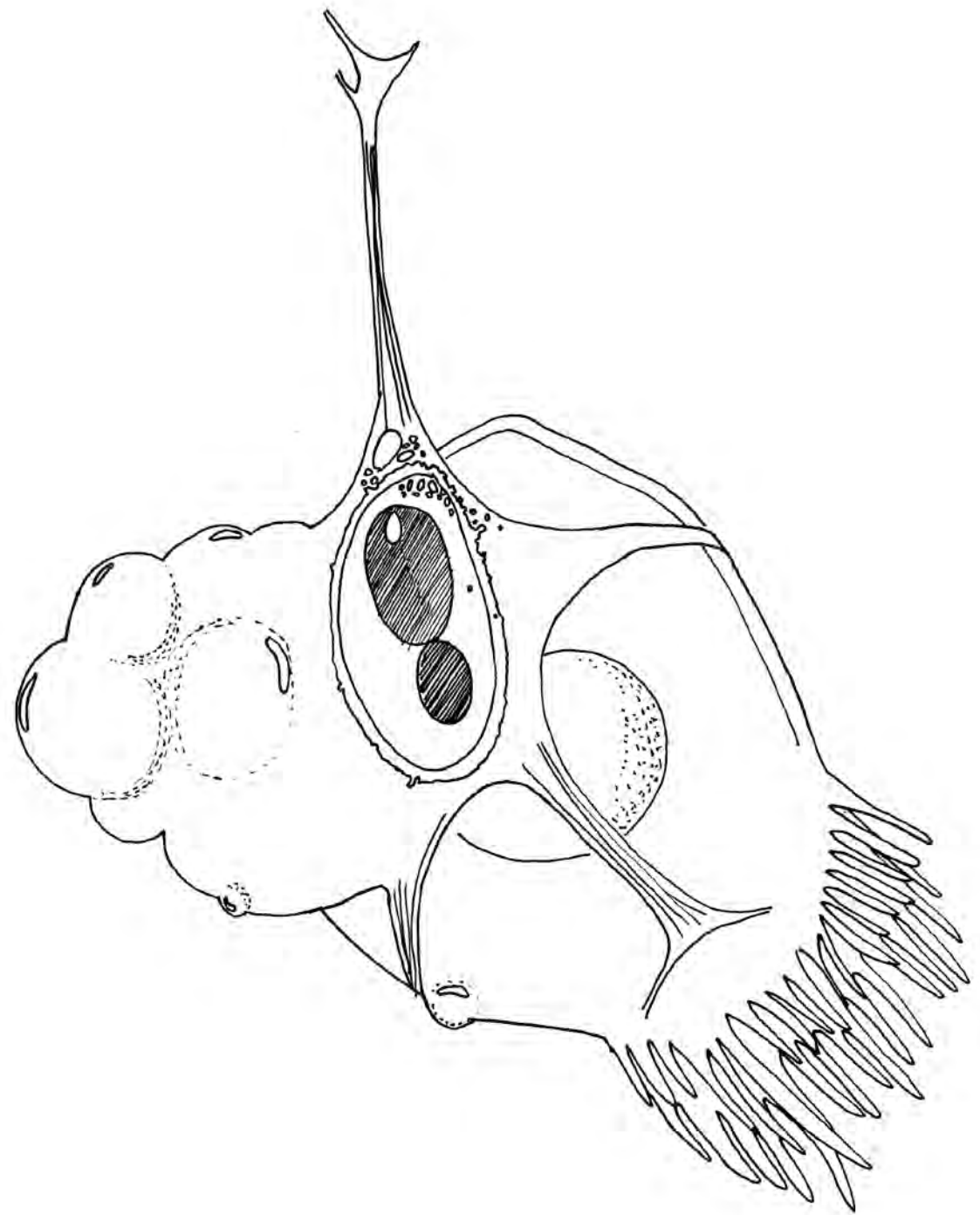
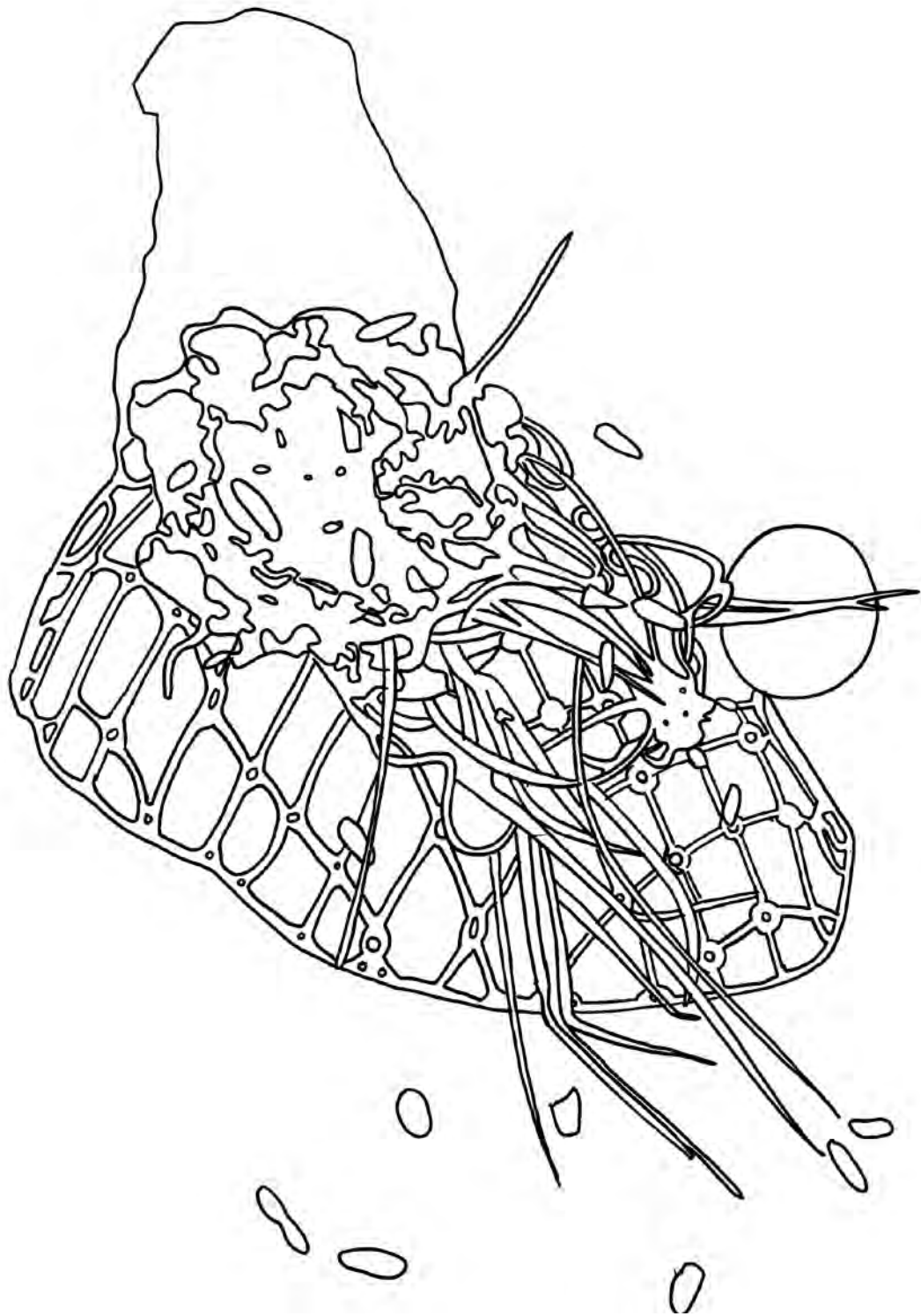

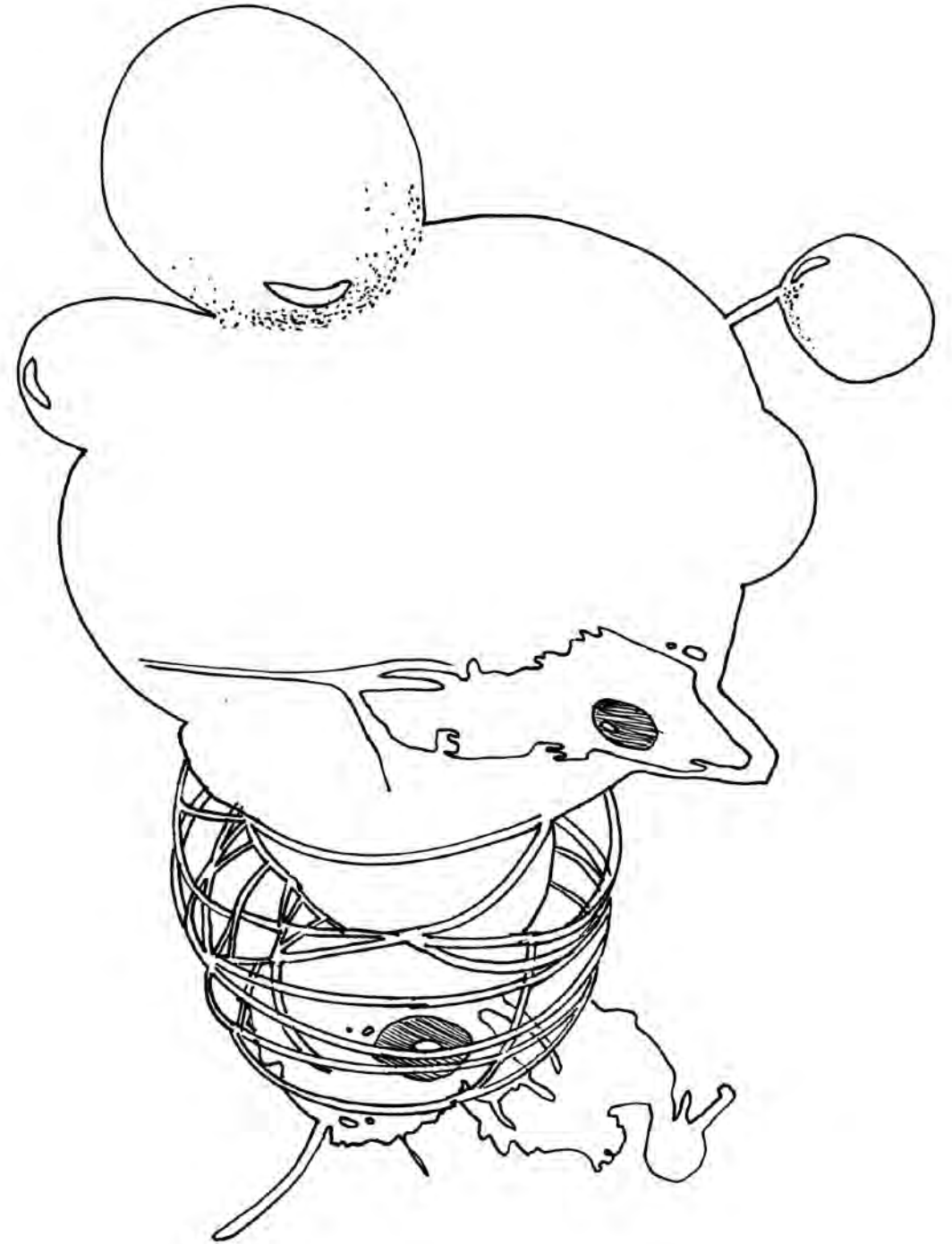
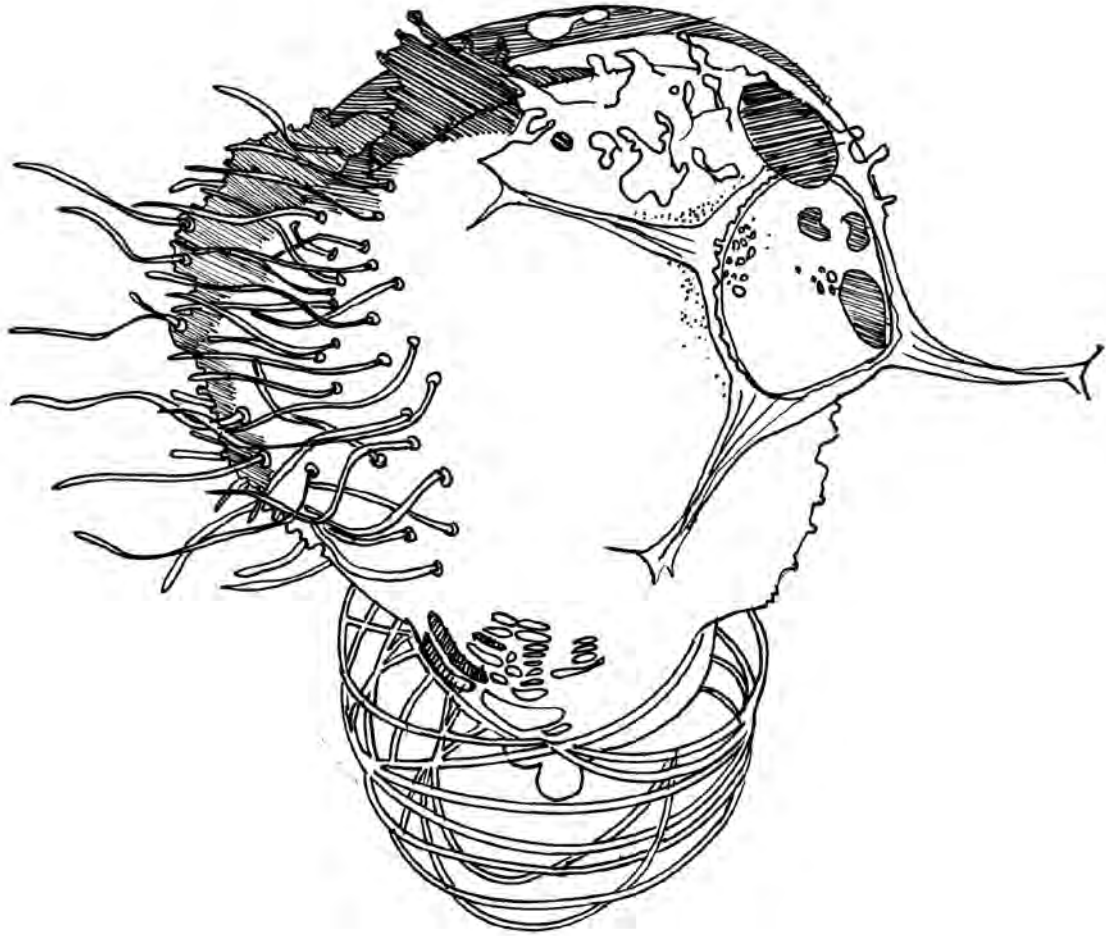

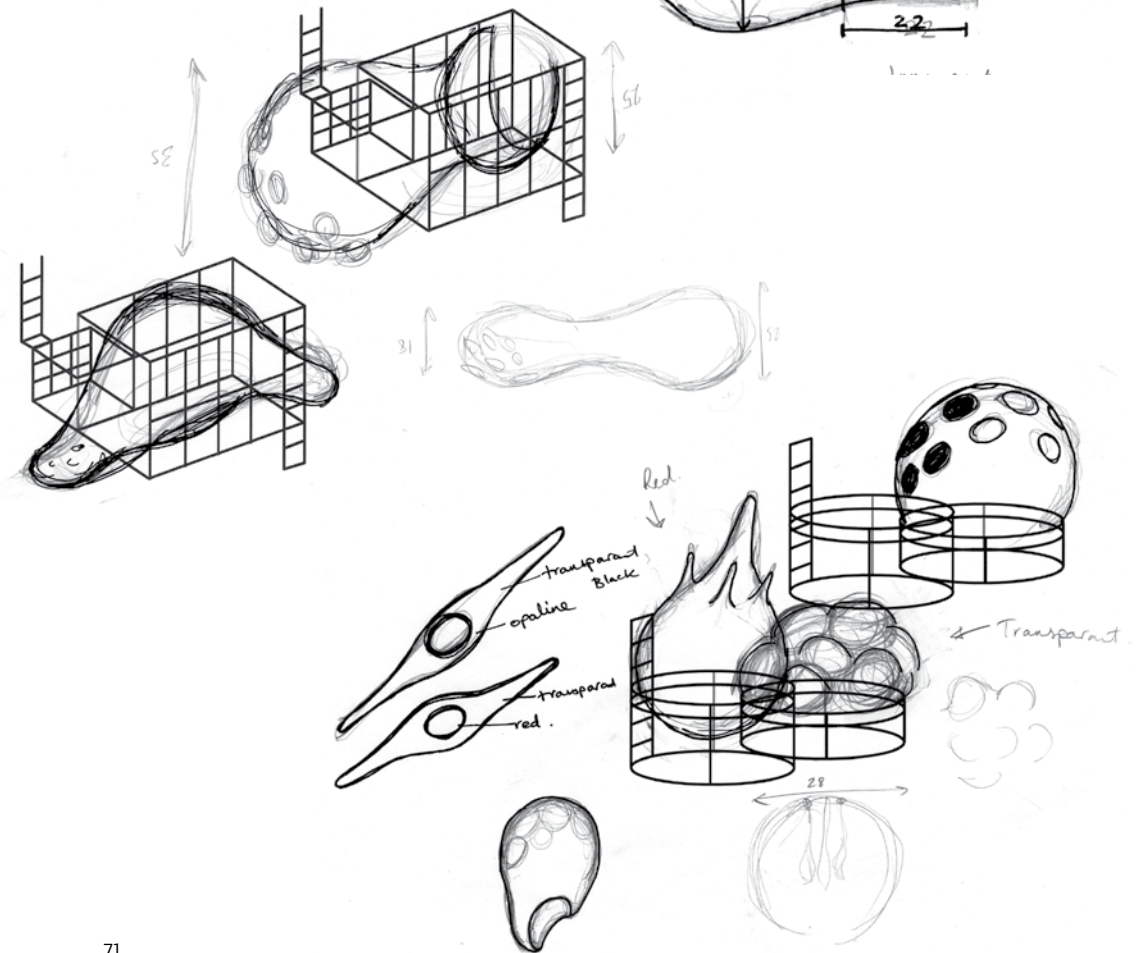
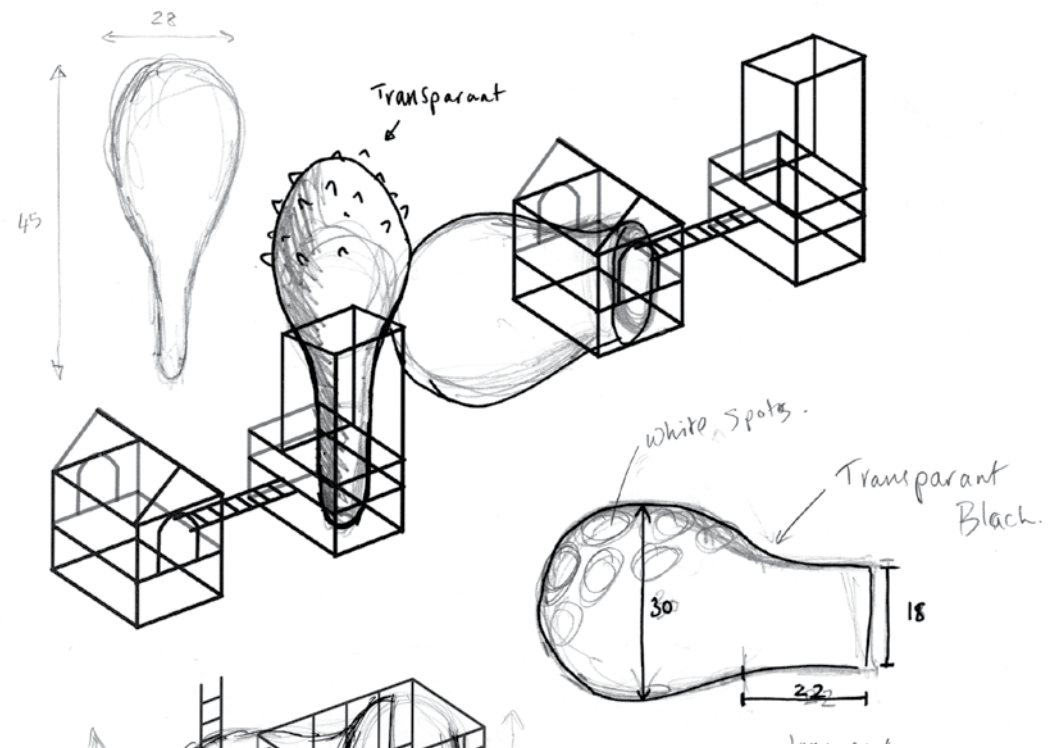
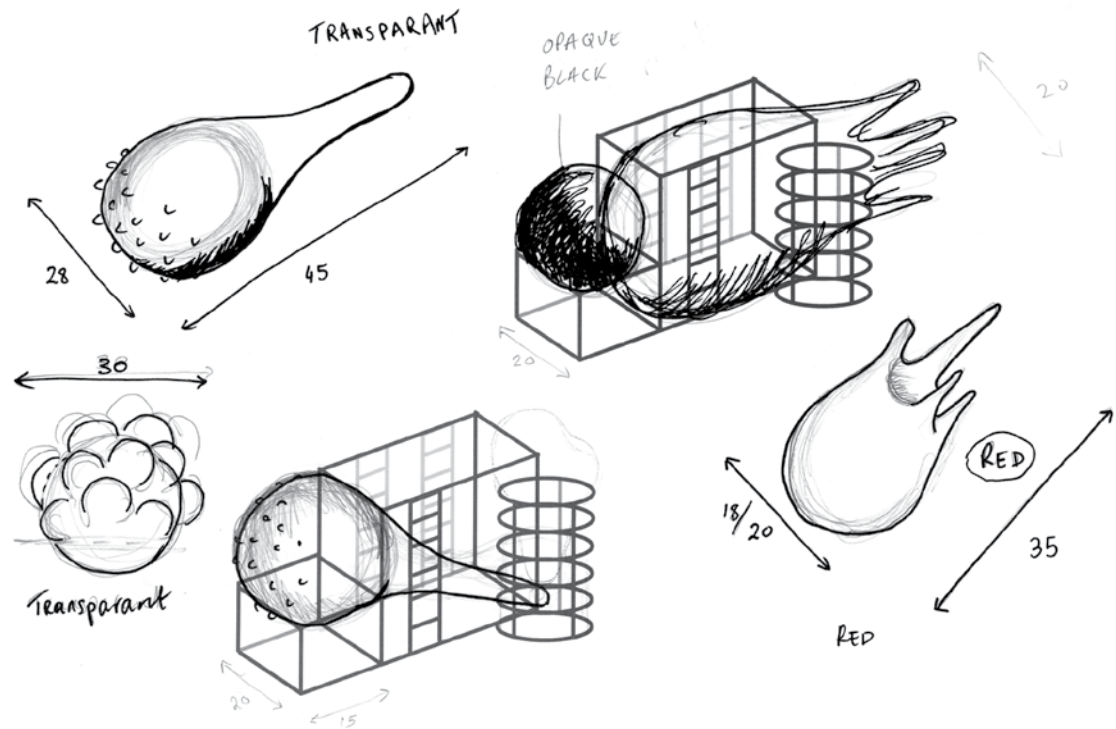
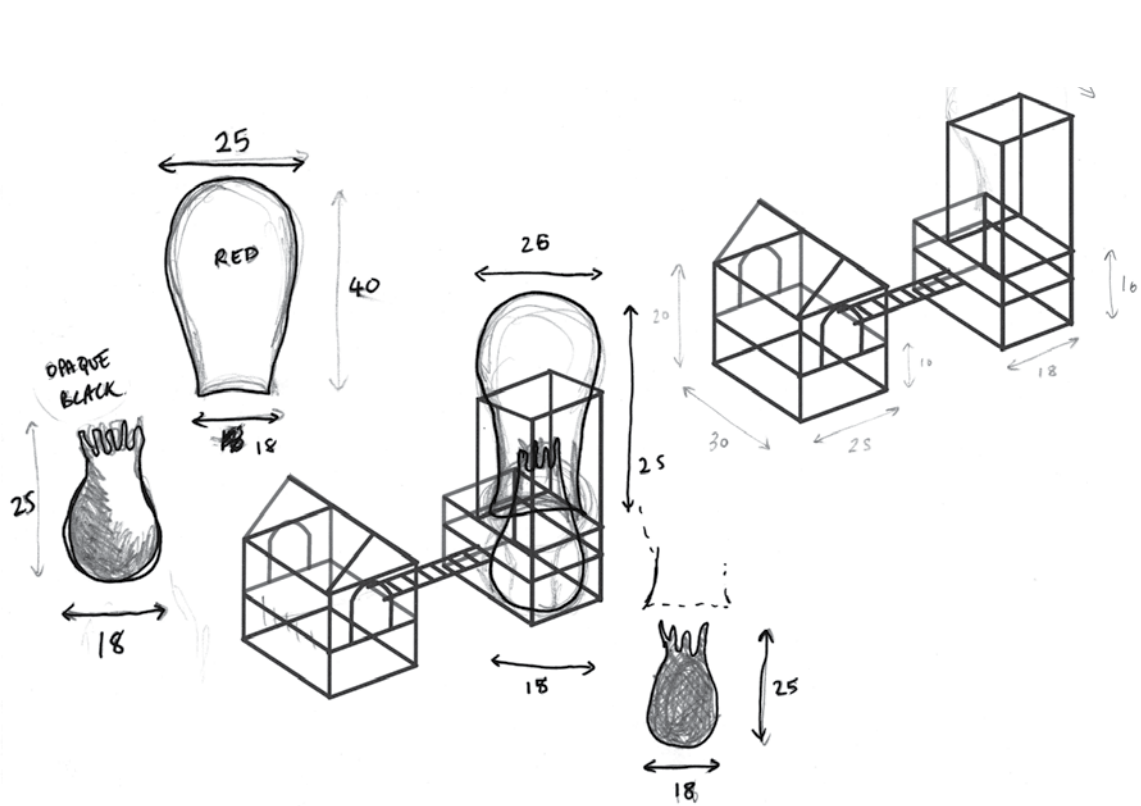



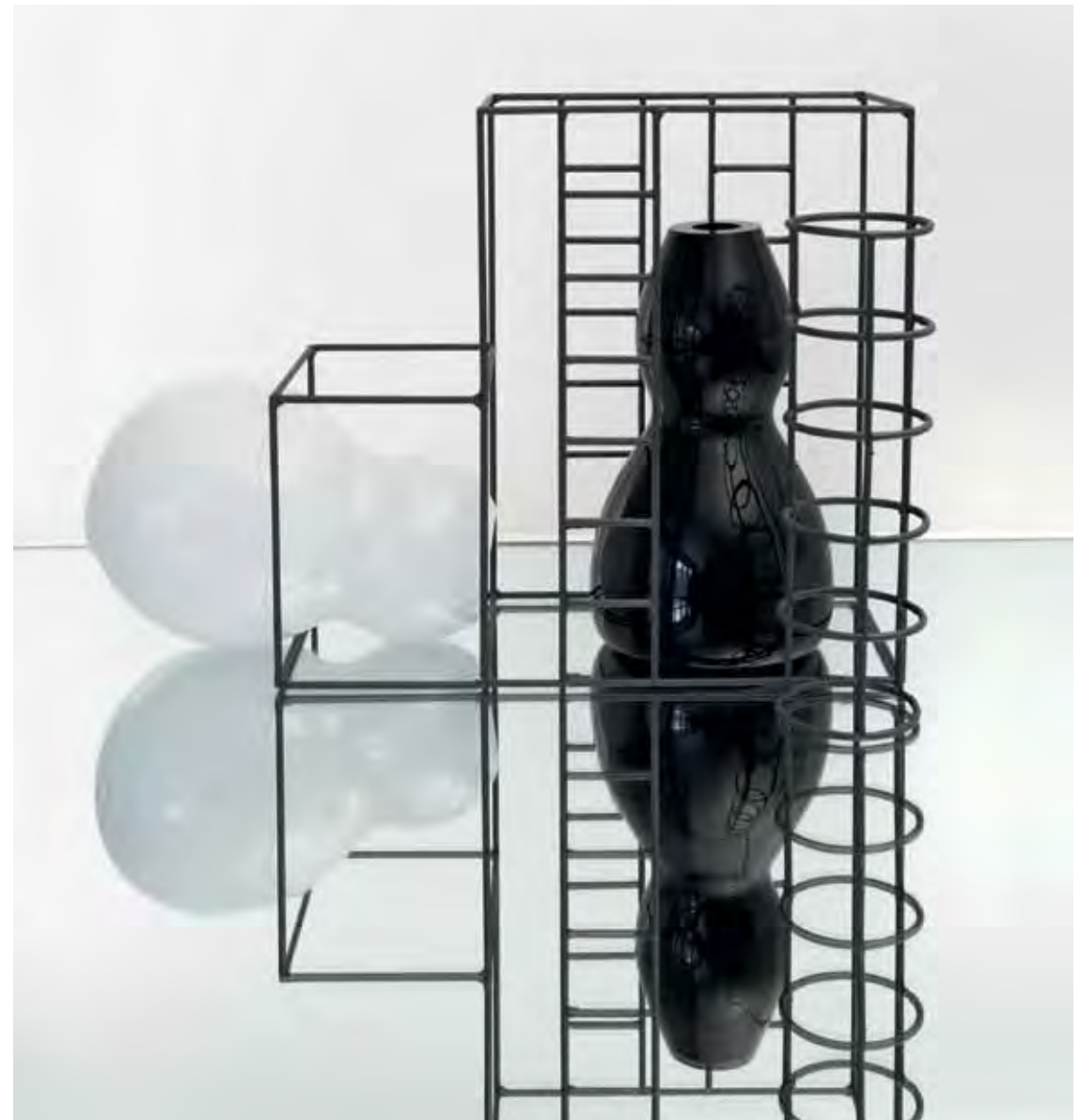
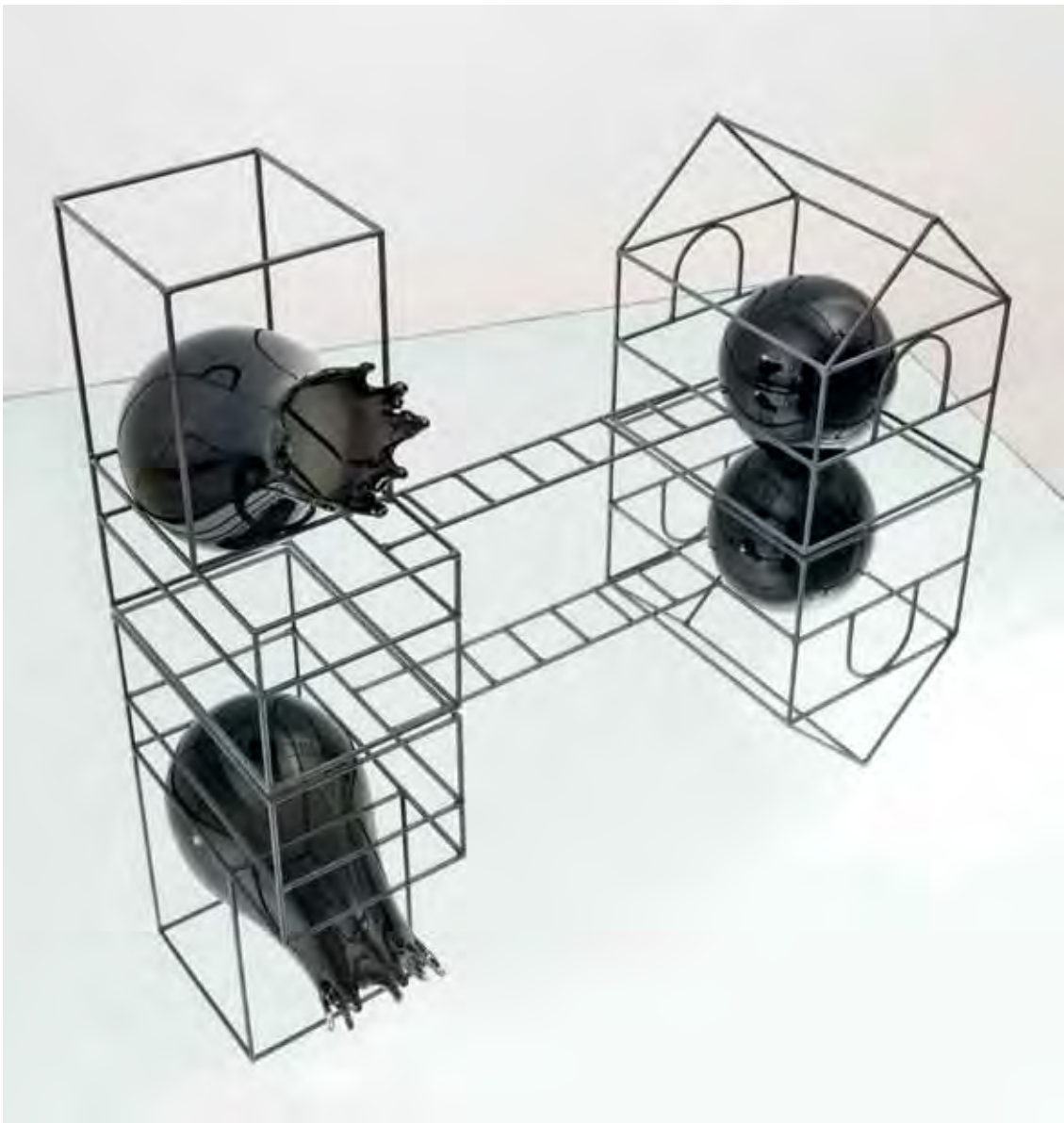



Totipotent Architecture - Les Moulins Reservoirs III, 2009-13



Totipotent Architecture - Les Moulins Reservoirs I, 2008



*(left)*  
Totipotent Architecture - Les Moulins Electricity Turbine Hall II, 2009-13

*(right)*  
Totipotent Architecture - Les Moulins Electricity Turbine Hall I, 2008









(left)  
Totipotent Architecture - Tuscan Cage, 2009-13

(right)  
Totipotent Architecture - Tuscan Cage with Crystal, 2009-13



(left)  
Totipotent Architecture - Temple, 2009-13  
(right)  
Totipotent Architecture - Minarets, 2009-13





*(left)*  
Totipotent Architecture - Temple with Tower, 2009-13

*(right)*  
Totipotent Architecture - Water Tower in Black, 2009-13





(left)  
Totipotent Architecture - Mecca, 2009-13  
(right)  
Totipotent Architecture - Water Tower in Black, 2009-13





Totipotent Architecture - Twin Towers, 2009-13

# Cellular Archaeology

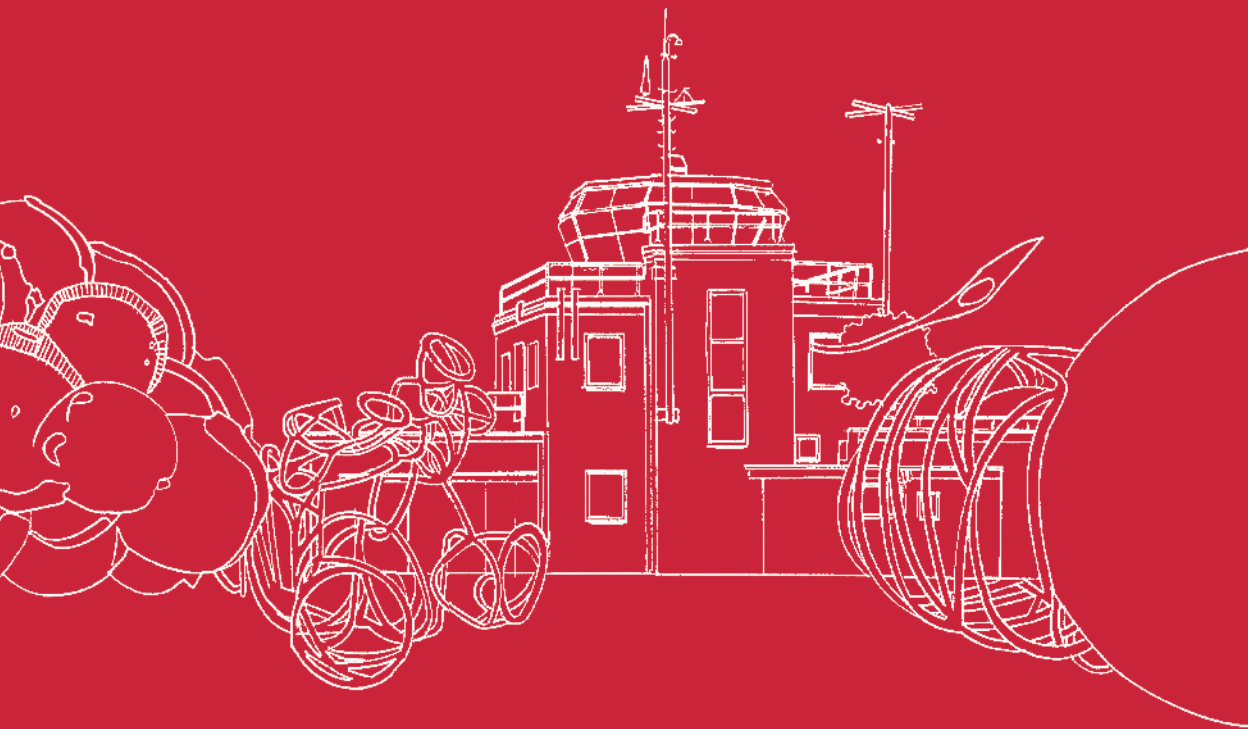

The former RAF station and later Cold War US airbase at Greenham Common has long been a contested place. The landscape here resonates with contradictions and with conflict: the Common, with its implication of openness and collegiality, versus the fenced and divided territories of militarized space; the order and monumental architecture within the fence, versus the free will of those beyond it, marking their space with temporary and transient structures, conducting alternative rituals and free-form artistic expression. The Peace Women who occupied space beyond the fence attempted to subvert the authority and order of those within—painting fence posts and marking the fences with woven webs and patterns. They lived their lives in camps, named after colors and each with distinctive social characteristics. Caroline Blackwood described the camp at Yellow or Main Gate as having a “special urban desolation that made it grimmer than the rest,” while Green Gate (est. 1983), which she called the Camp of Intellectuals, possessed of a “cosmic” atmosphere. There was also a camp at Musicians’ Gate and one at Blue Gate, which developed a reputation as comprising “tough, rowdy youngsters.” The Peace Women who occupied the camps consider these locations “sacred,” while others consider them “scarred” by either the presence of militarism or the Peace Camps, or both. Either way it is a diverse landscape richly woven with complex (hi)stories.

Greenham’s history runs deeper, however, than just the Second World War and Cold War periods. Stone Age artifacts were found here, and military encampments are recorded in the seventeenth and eighteenth centuries. But it is surviving remains of the late twentieth century that are remarkable. Within the fence is the former technical site of the airbase, now a business park. The former airfield has returned to common land, but a section of runway has been retained as a bizarre memorial to this recent history. The control tower also survives, as does, spectacularly, GAMA (Ground-launched cruise missile Alert and Maintenance Area), six massive concrete shelters, and various bits of associated infrastructure, all now protected as a Scheduled Monument. Beyond the fence are subtler traces of the camps: the painted fence posts, artifacts scattered in the woods, and the earthwork traces of habitation areas, including leveled areas for tents (benders) and hearths. Finally, there is the fence itself, a key and characteristic monument of the Cold War, uniquely representative of a central conflict within Cold War geopolitics, not between East and West but among those in the West who disagreed over nuclear (dis)armament.

## Archaeology of the Contemporary Past

Greenham also has a place in the development of an increasingly significant and popular branch of archaeology: archaeology of the contempo-



rary past. This archaeological approach takes no account of time depth; it recognizes that conventional archaeological methods as well as conceptual and theoretical frameworks can be applied to periods of living memory, just as they can to the deeper past. The methods archaeologists use can reveal and record traces of a Stone Age campsite on the Common *and* a camp site abandoned twenty years ago, or even yesterday. It can be done. Some skeptics might argue, what is the point? This was a question raised following a presentation, made locally, to raise funds for the contemporary archaeological project at Greenham. I paraphrase, “Why would you want to record the locations of crisps bags and old bottle tops?” “For two reasons,” I replied (not convincingly—we did not get funding). “One, what we consider the familiar past is not so familiar when we start to examine it in closer detail. Examples abound of archaeological projects that seek to study things we think we know all about, only to be surprised by the results. Two, sometimes what matters is not what we find but the process of doing the work. In this case fieldwork might provide the opportunity for people with an interest in Greenham, or with personal connections to the site, to come together, to meet, talk and cooperate in something that would be fun and perhaps—in some ways—cathartic for those involved.” That, at least, was the plan.

What actually happened was rather different, partly because of a lack of significant funding, and partly because our approach to Greenham changed, something I return to below. But fieldwork was achieved, due largely to Council for British Archaeology (CBA) funding, which allowed a small and cross-disciplinary team to focus on one of the camps. Here the study is described briefly.

### Mapping Turquoise Gate

In a project directed by Yvonne Marshall and supported by the University of Southampton and the CBA Challenge Fund grant, work was undertaken at Turquoise Gate, a camp established in December 1983 by women from Blue Gate seeking a separate vegan zone. It was among the shortest lived of the Greenham camps, and was occupied intermittently by small numbers of women. The work was in three stages.

First, we mapped topography, vegetation, and all visible cultural features and artifacts. We identified a concentration of protest-related artifacts, which as a second stage we subjected to more detailed, intensive survey, recording and collecting by square meter all objects exposed on the ground surface. We identified two clear features at this second stage: the base of a scrap wood structure, and a large fire pit. Some 150 objects were recovered including car parts, bricks, concrete, tiles, wood, wire, plastic

sheeting, plastic bags, clothing, wrappers, cans, bottles, kitchen utensils, toys, and pharmaceuticals. The personal, domestic nature of many of these items ties them strongly to the occupants of the camp, and one—a discarded Smiths crisps wrapper bearing promotional information about the James Bond film *Octopussy*, released in 1983—is definitively placed during the camp’s occupation phase. We also recovered a doll’s torso, identical to that found in a photograph published around 1985 showing doll body parts attached to the fence. The aim of protestors, some tell us, was to soften the fence; to subvert it, make it look less male, less military, and more ridiculous. This was achieved through acts of transgression and by translating context—putting private things on public view, or creating something exquisite from the rubbish.

As the project developed we came to realize the sensitivity of the camps to the women who had occupied them, and the methodology for our third stage changed as a result. Notably, objects were no longer collected, but recorded in situ and left as found. Three-dimensional point locations were captured for every artifact allowing spatial analyses to be conducted within a Geographical Information System, a project undertaken by Kayt Armstrong.

Not collecting surface artifacts allowed us to cover larger areas and a wider, more extensive survey

revealed further hearths, stashed building materials, milk bottles, face cream jars, and the remains of shelters beyond the area originally studied. Some 475 artifacts were recorded in this way, mostly occurring in two clusters that displayed subtle differences in the types of evidence contained—raising the possibility that camp activities could be reconstructed, much as archaeologists describe activity zones at ephemeral occupation sites from early prehistory.

The nature of the objects and their spatial distribution challenged the identity of Turquoise Gate in literary and oral history. It was supposed to have been a camp of vegans, separated from Blue Gate. Yet the boundary between the two sites is not distinct, suggesting some spatial continuity. There were also a significant number of milk bottles on site. Were the women really all vegan, or were they reusing the bottles? Were there children on site who needed milk? Perhaps the identity of the camp was blurred, yet clearer and more distinct in the way women remember it?

Among the many visitors who helped during fieldwork were two former Peace Women, Lorna Richardson and Lynette Edwell. They took us to the small, previously unrecorded camp at Emerald Gate, which they had occupied on various occasions to monitor GAMA. The camp at Emerald





Gate was found intact, with personal utensils and rolled polythene sheeting used for benders still in their original hiding place, or “cache,” under gorse bushes. The moment when Lorna Richardson rediscovered her own coffee mug seemed to sum up the Greenham archaeological project and what we had set out to achieve.

### Lucy + Jorge Orta

Given the strong artistic content in many of Greenham’s protest actions, it was fitting that artists were part of the fieldwork, contributing to documentation of the site and the process of studying it, and responding to the project as it evolved. Kristin Posehn, then undertaking doctorate research at Winchester School of Art, photographed and filmed the fieldwork process, capturing key moments and significant discoveries. Some of her photographs accompany this essay.

Partnership with Lucy + Jorge Orta extended beyond mere recording and documentation. The artists formed a central part of the research group, contributing thoughts on research focus and direction and, crucially, on the connections between art and archaeology. How might one influence the other, and how might these influences drive the project in new directions, opening up new avenues of inquiry, and new research questions? Much of Orta’s previous work examined the social connections within

and across communities, and the relationships between individuals and their environments. In the early 1990s, Orta began a series of works that combined architecture, fashion, and social activism to create temporary refuges, prototype survival clothing, portable shelters, and tent villages for emergencies, project outputs that have obvious resonance with events at Greenham.

Lucy Orta and I shared the billing at a 2007 *Situations* conversational event in Bristol. In her contribution Lucy described the emergence of an idea of what her Greenham project might produce. As she said, “One would have expected me to respond with a proposal for a tent village installation, an encampment ‘revisited,’ or a reenactment of ‘Embrace the Base’—the most important of the demonstrations, where 30,000 women linked hands to encircle the base. But as we all know, artists can be pretty unpredictable!”

Lucy described how, in the six months prior to joining the research group, she and her partner Jorge had the opportunity to encounter molecular scientists looking at communication on a genetic level and biologists working in embryonic cell development. What fascinated them then was the process of differentiation, whereby cells specialize and become multipotent with unique functionality. Predicated from Dolly the sheep research in 1997, stem cell

lines now can be purposely differentiated from one cell type to another. This “energy transformation,” whereby one cell becomes something completely different, was the starting point for a new body of work developing less transient artworks and creating forms that are infinitely mutable or *totipotent*.

Orta’s early research on transient architecture conducted throughout *Refuge Wear*, *Body Architecture*, and *Modular Architecture* reflected on the immediate layers surrounding the body. This new research would allow them to lead away from the scale and intimacy of the individual and into the context of a wider socio-urban environment.

The space that most intrigued Lucy during her site visit to Greenham was the Control Tower, the highest control point overlooking GAMA’s missile shelters and the surrounding common. As the tower currently lies vacant and its future uncertain, would it be possible, she wondered, to transform this highly symbolic building into something with renewed artistic potential? The proposal she and Jorge presented to the group was an idea to draw up plans for the Greenham Common Visitors Center, a place where histories converge, a space for archives, data, and oral histories to become public. The Control Tower thus became the artists’ space of intervention where they could investigate totipotency, searching for a new life, a new body.

### Conclusion

In *Lucy Orta, Process of Transformation*, Cristina Morozzi described how cells are part of the human body:

“[Cells] are at the origin of its being, its feelings, its emotions and its sufferings. Thus, they speak the language of the body. There are also cells of habitation. The relationship between people and their habitat is formed in this metaphorical cell. Living and being become a single and unique life experience.... The term cell is also used to indicate political and social groups; groups of people cemented together by the same ideals, convictions and striking power. They represent a social context struggling for change.”<sup>1</sup>

The historical, social, and geographical context, that is to say the reality, in which the artist intervenes, takes on a certain importance when it is the subject of vision; it is a “cell,” and in so being, is a part of the body.

Greenham has become a *cause celebre* in contemporary archaeology: a key project in defining and scoping archaeologies of the contemporary past, demonstrating that it can be done. In time it may also exemplify the benefits of exploring the collaborative partnership of artists with archaeologists/historians, not so much for creating a documentation of the past but for analyzing it, deconstructing and critiquing it, and challenging people to engage with history in new and unforeseen ways. Perhaps totipotency is a model for achieving this (a *Cellular Archaeology*, if you will), for analyzing and thinking of places, things, and relationships as “infinitely mutable.” Lucy + Jorge Orta’s work was central to our collaborative project, a collaboration that ultimately reflected the spirit of Greenham: partnership, collegiality, and creative energy.

1. Cristina Morozzi, *Lucy Orta: Process of Transformation* (Paris: Editions Jean-Michel Place, 1996).

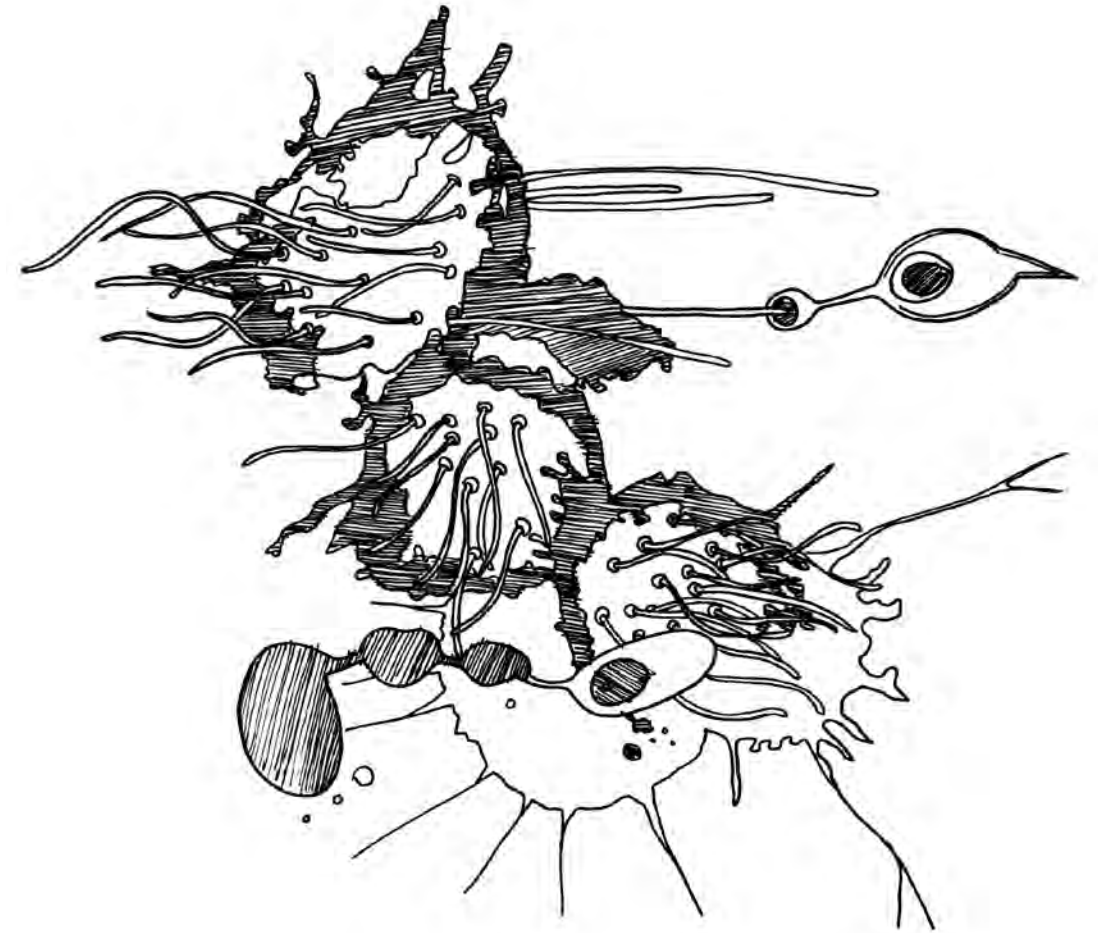
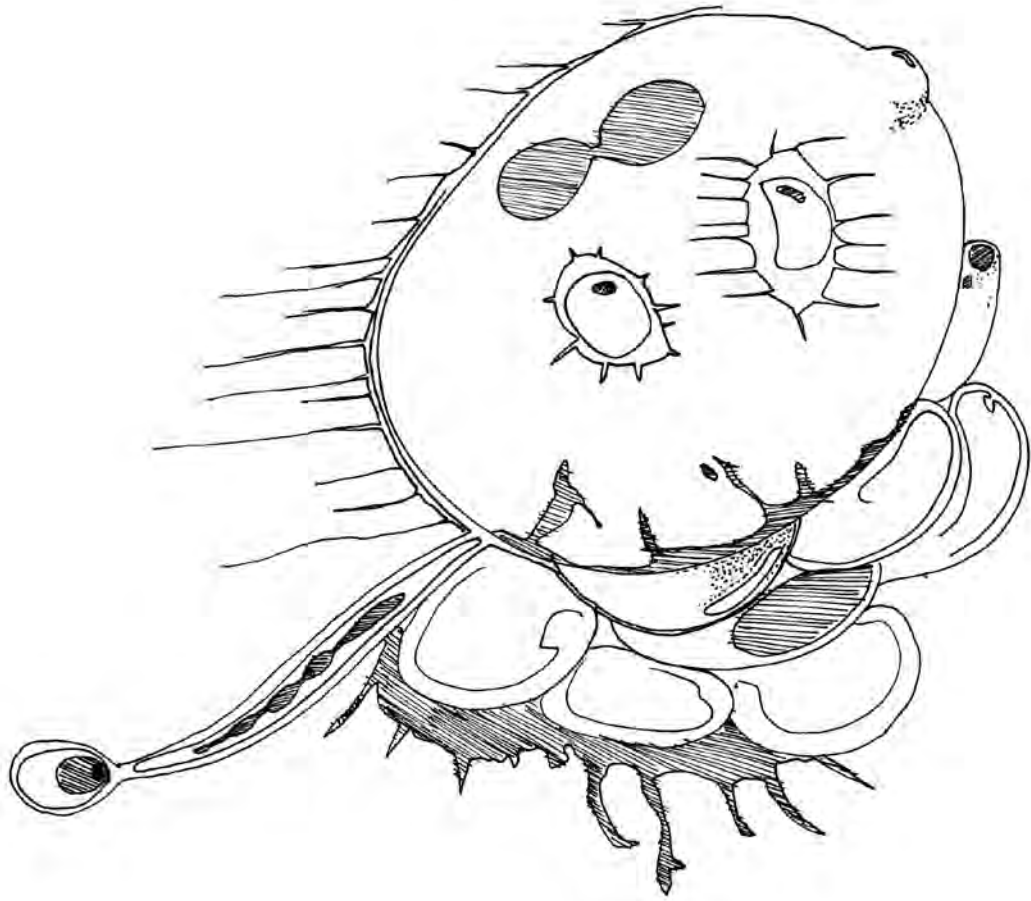

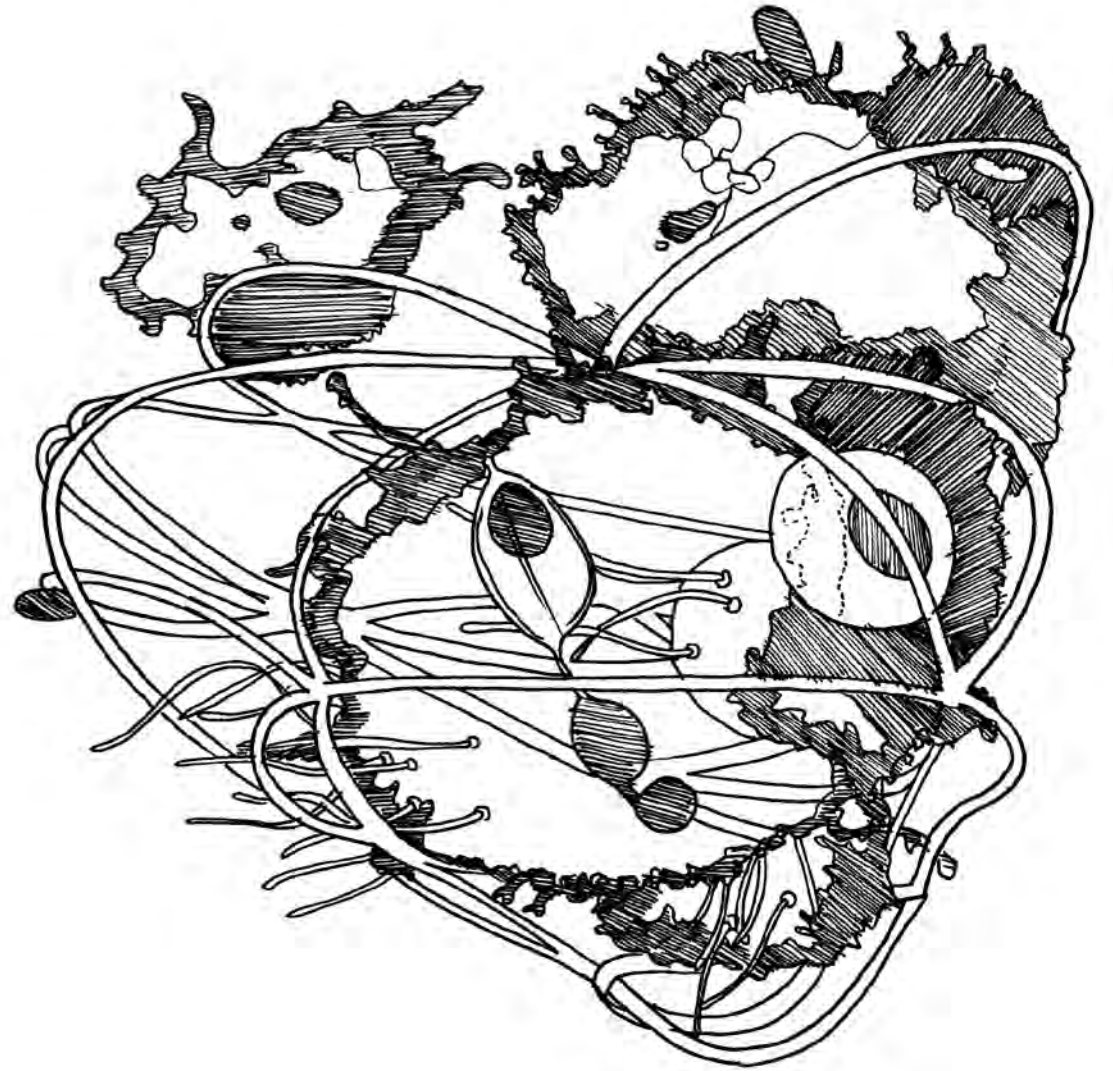
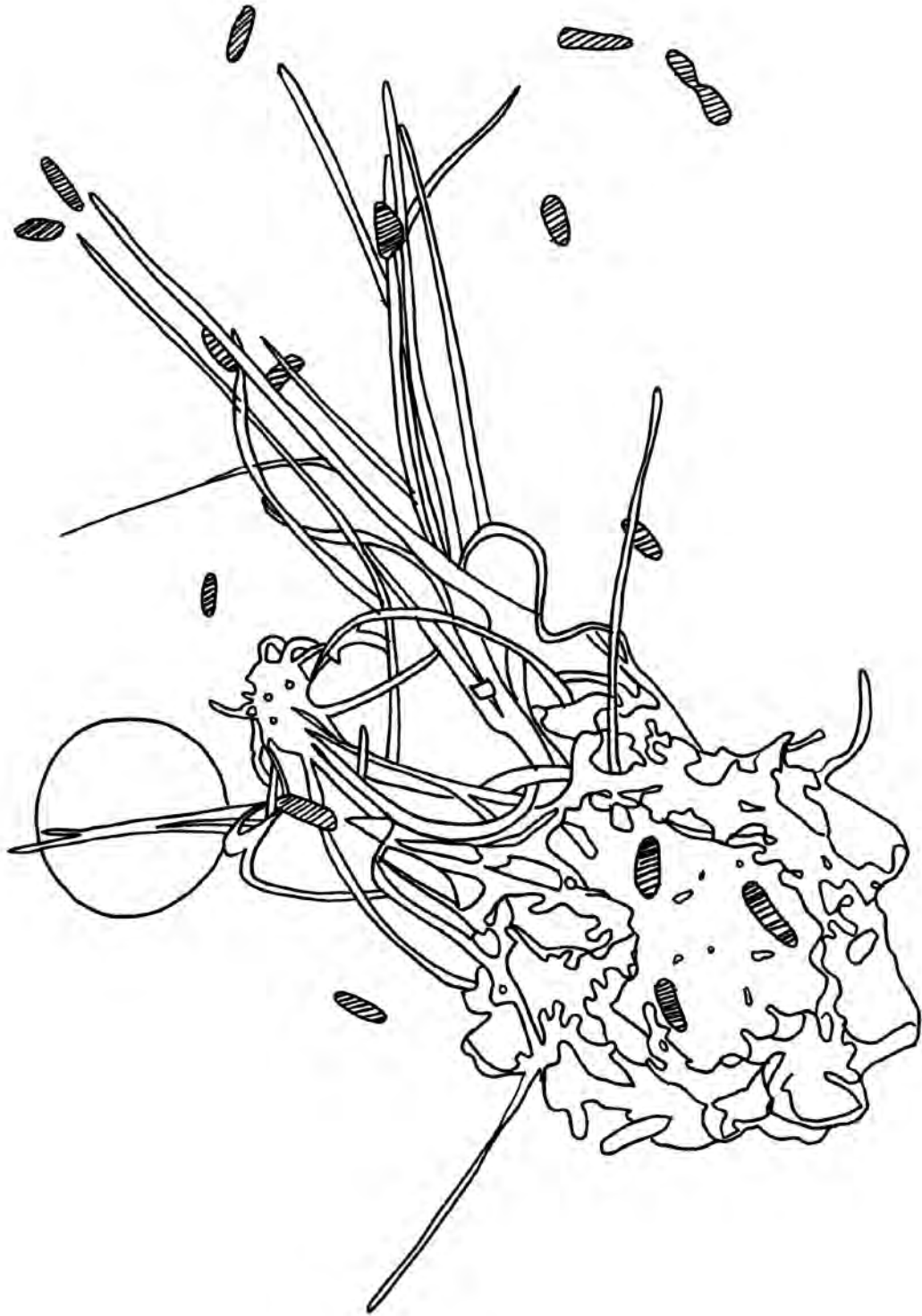

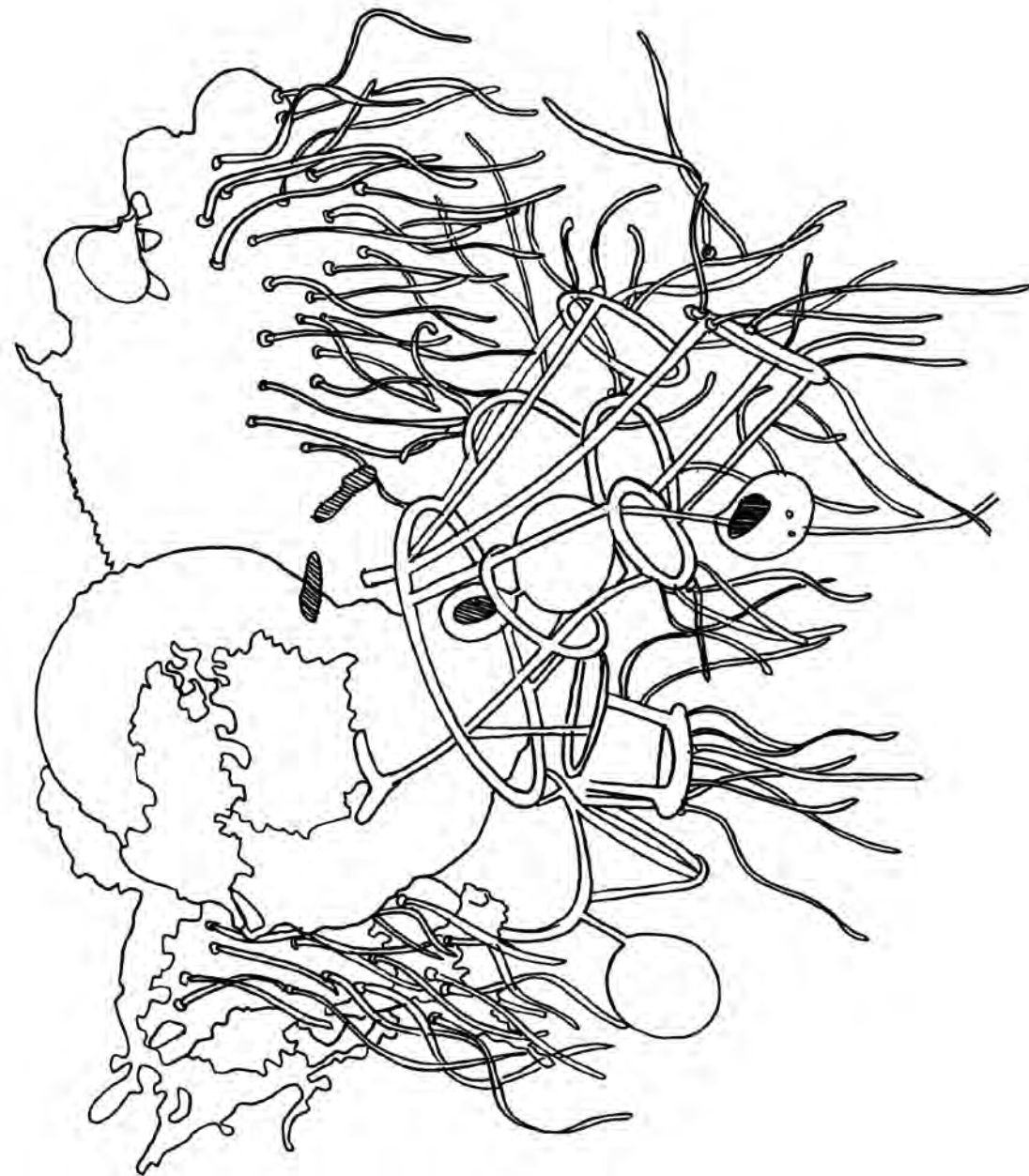
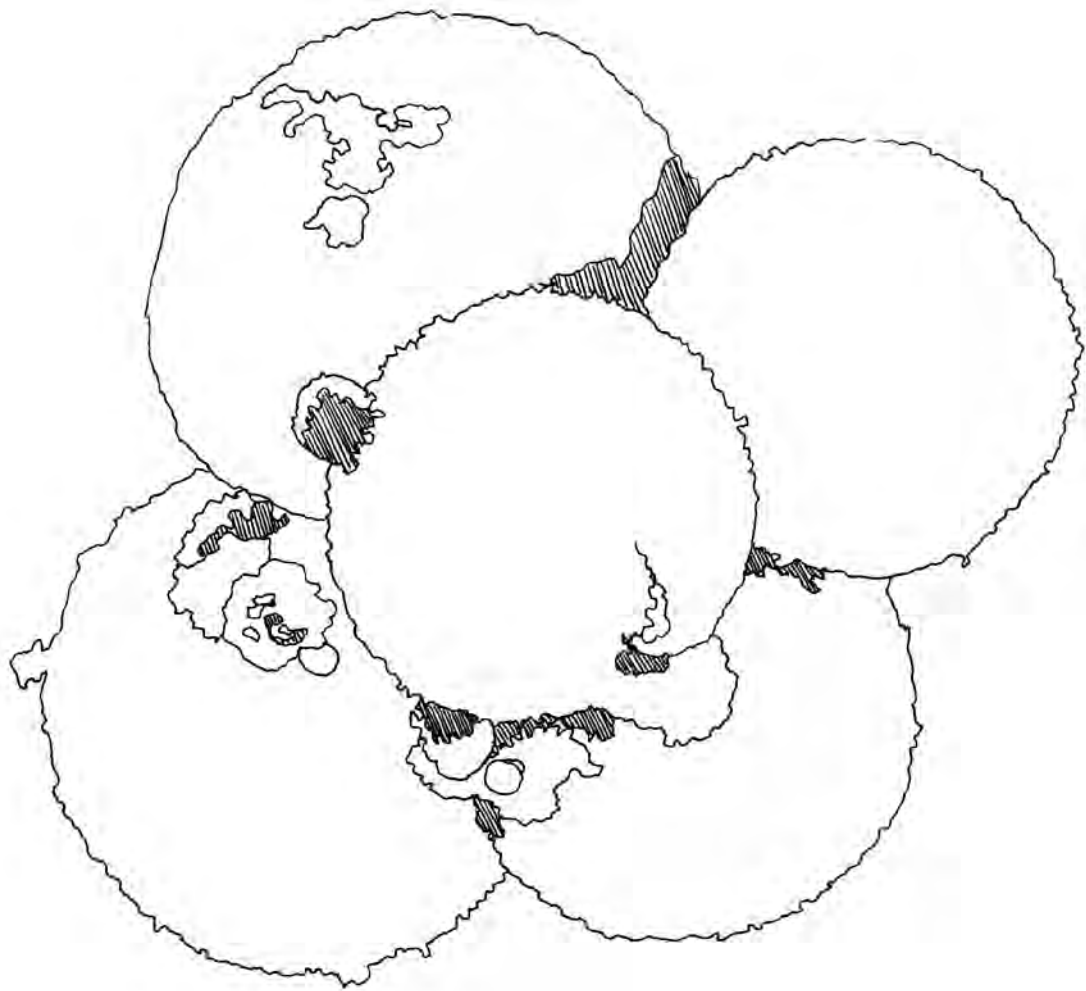



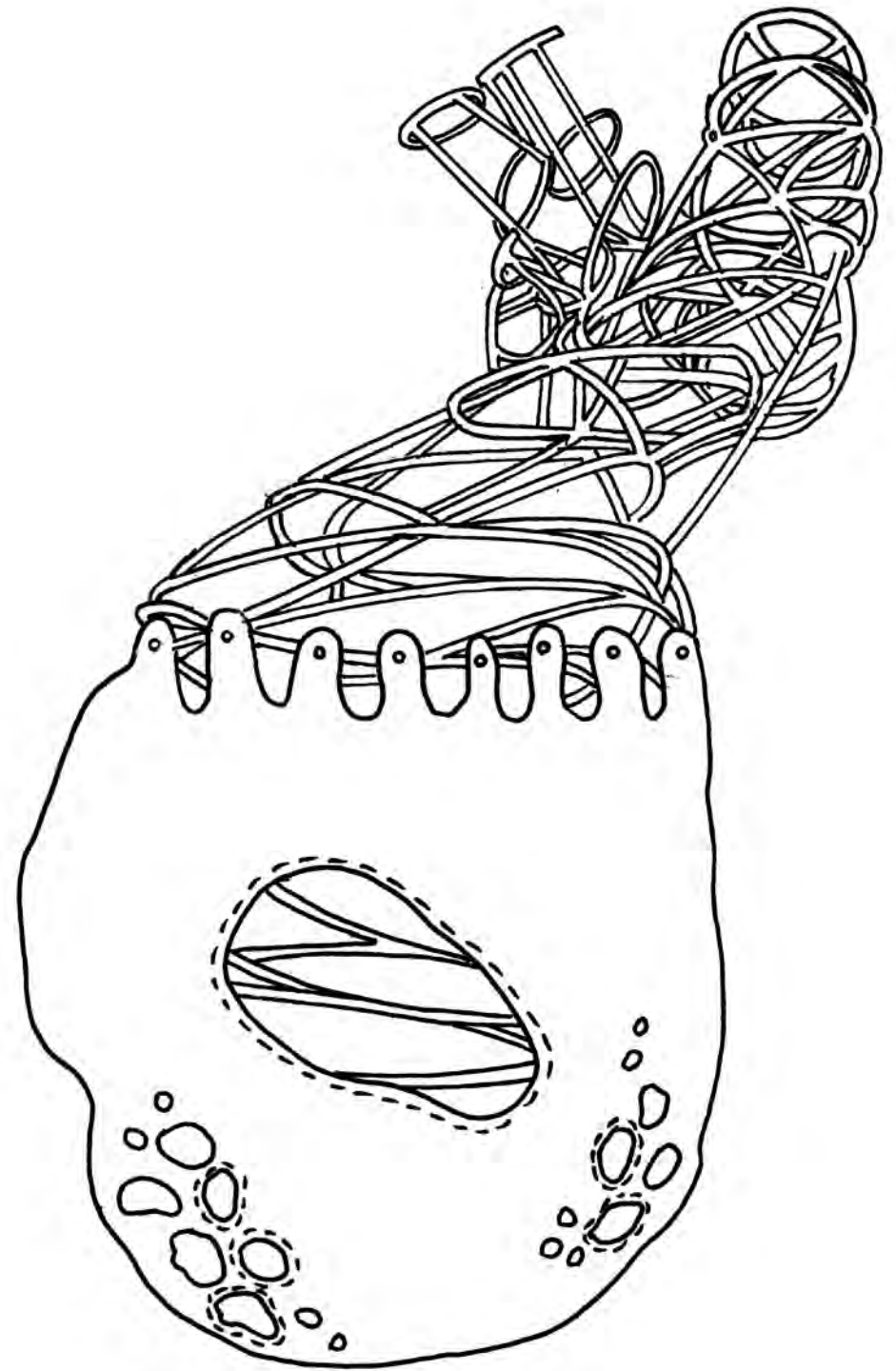
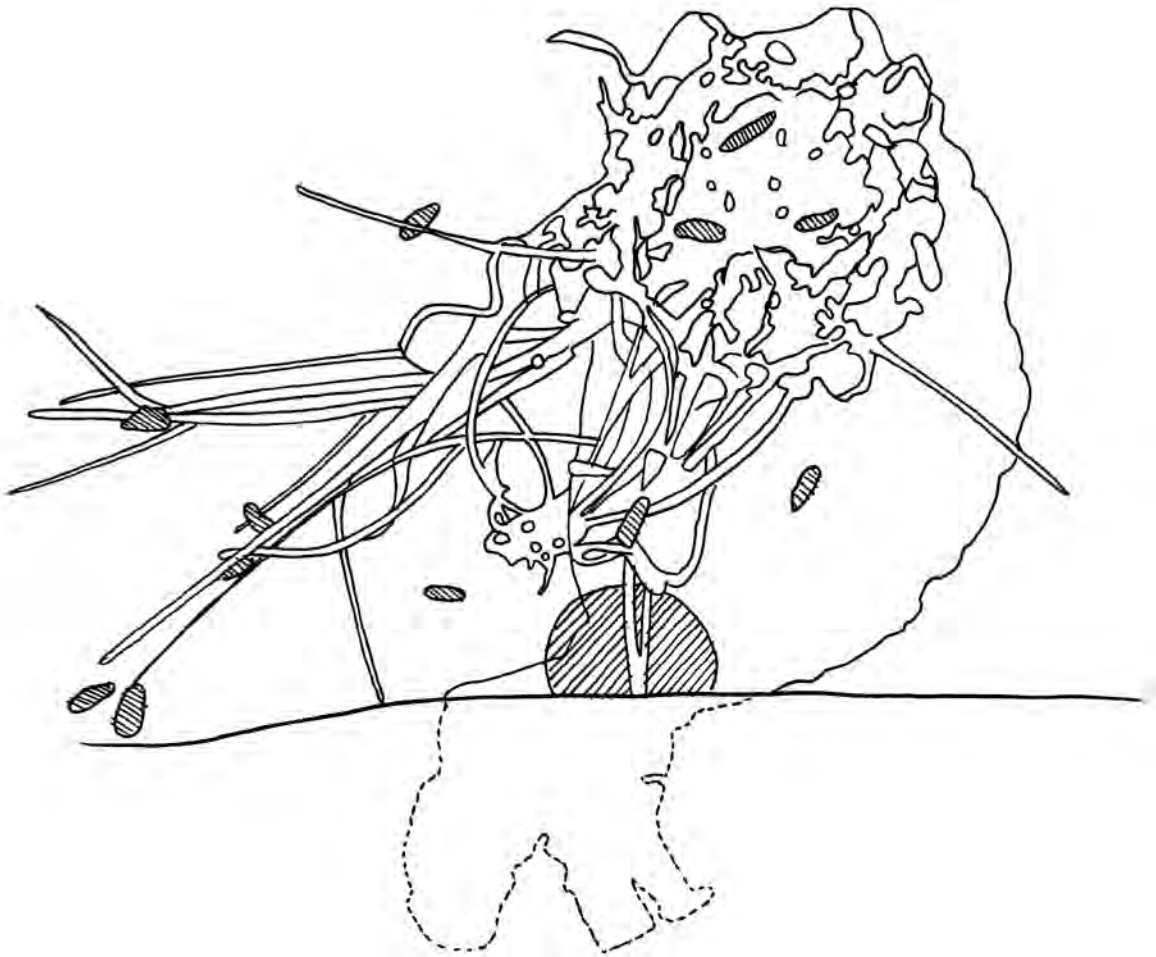

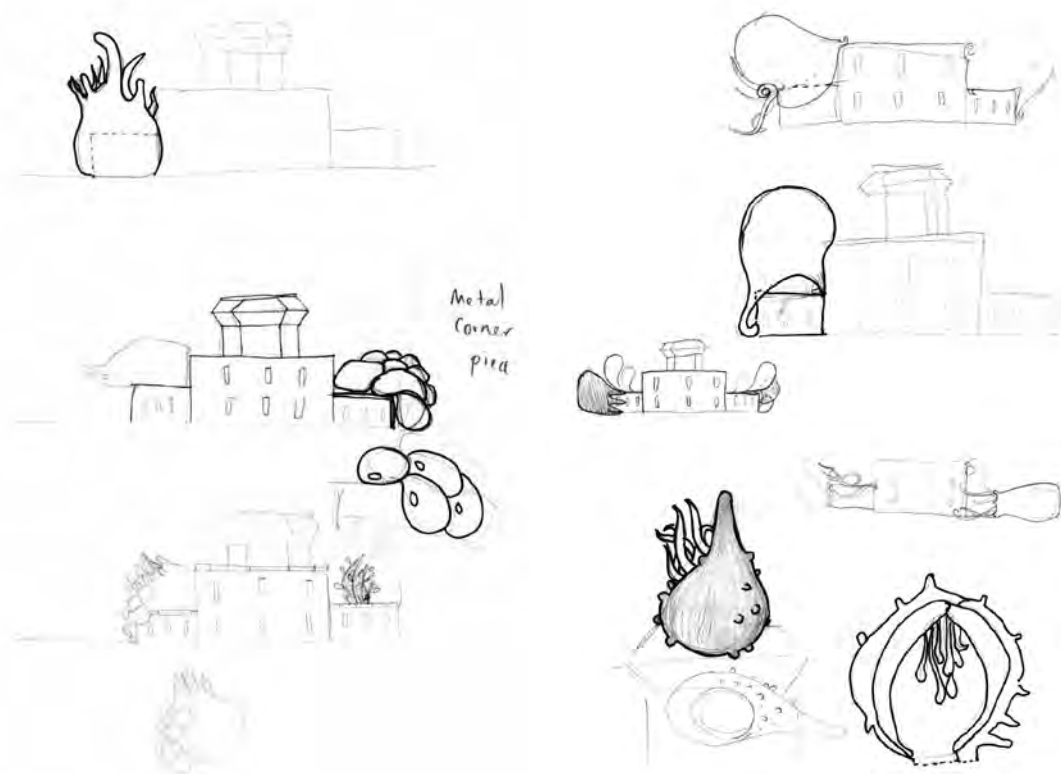
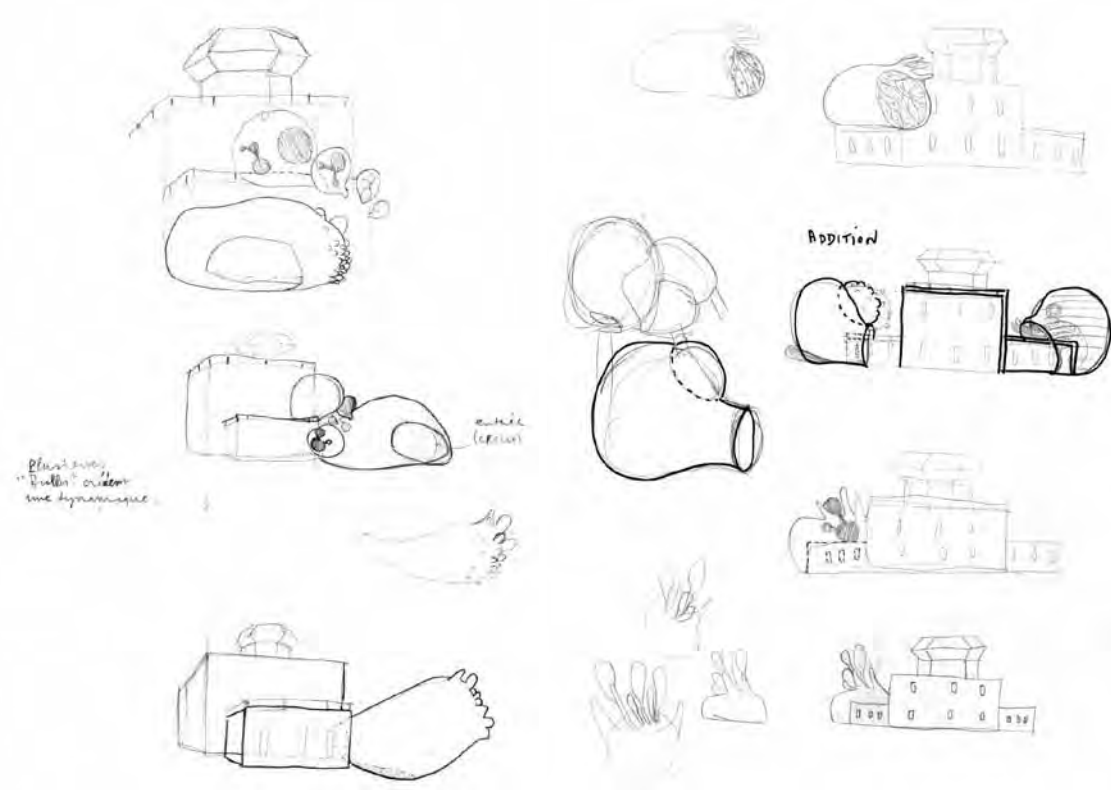
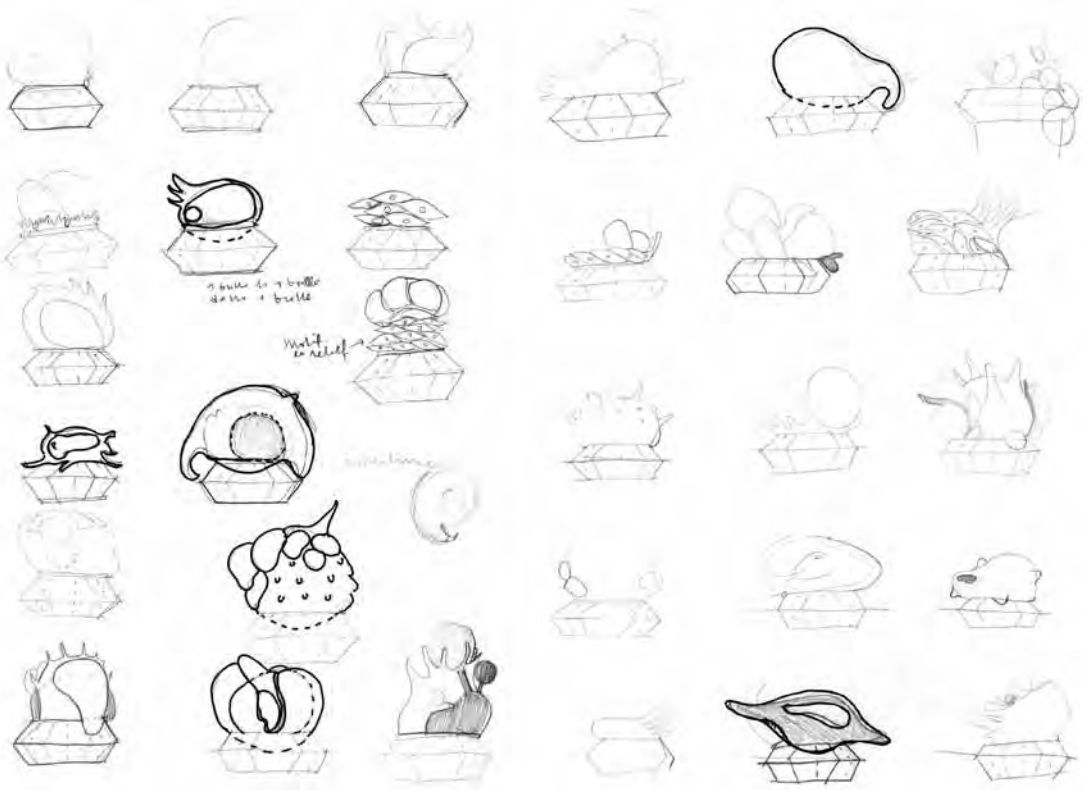

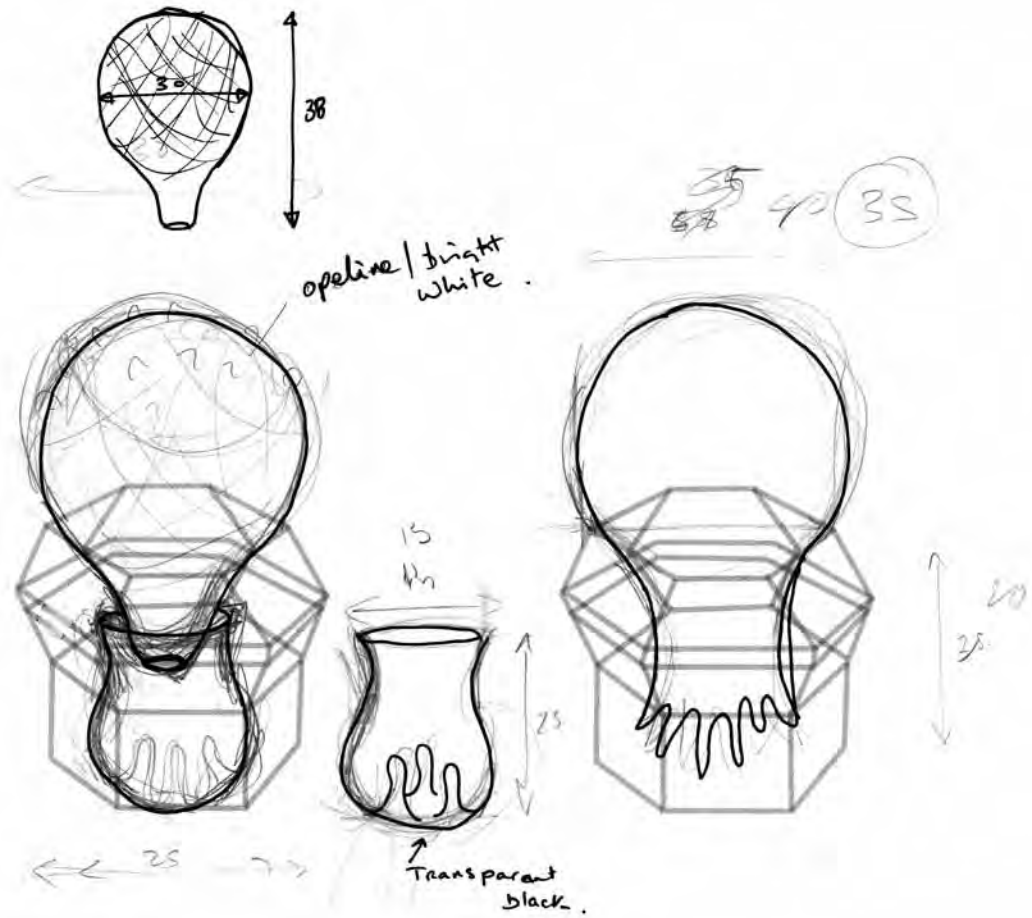

(left)  
 Totipotent Architecture - Control Tower Observatory, 2008  
 Sketchbook drawing

(right)  
 Totipotent Architecture - Greenham Common Observatory, 2008



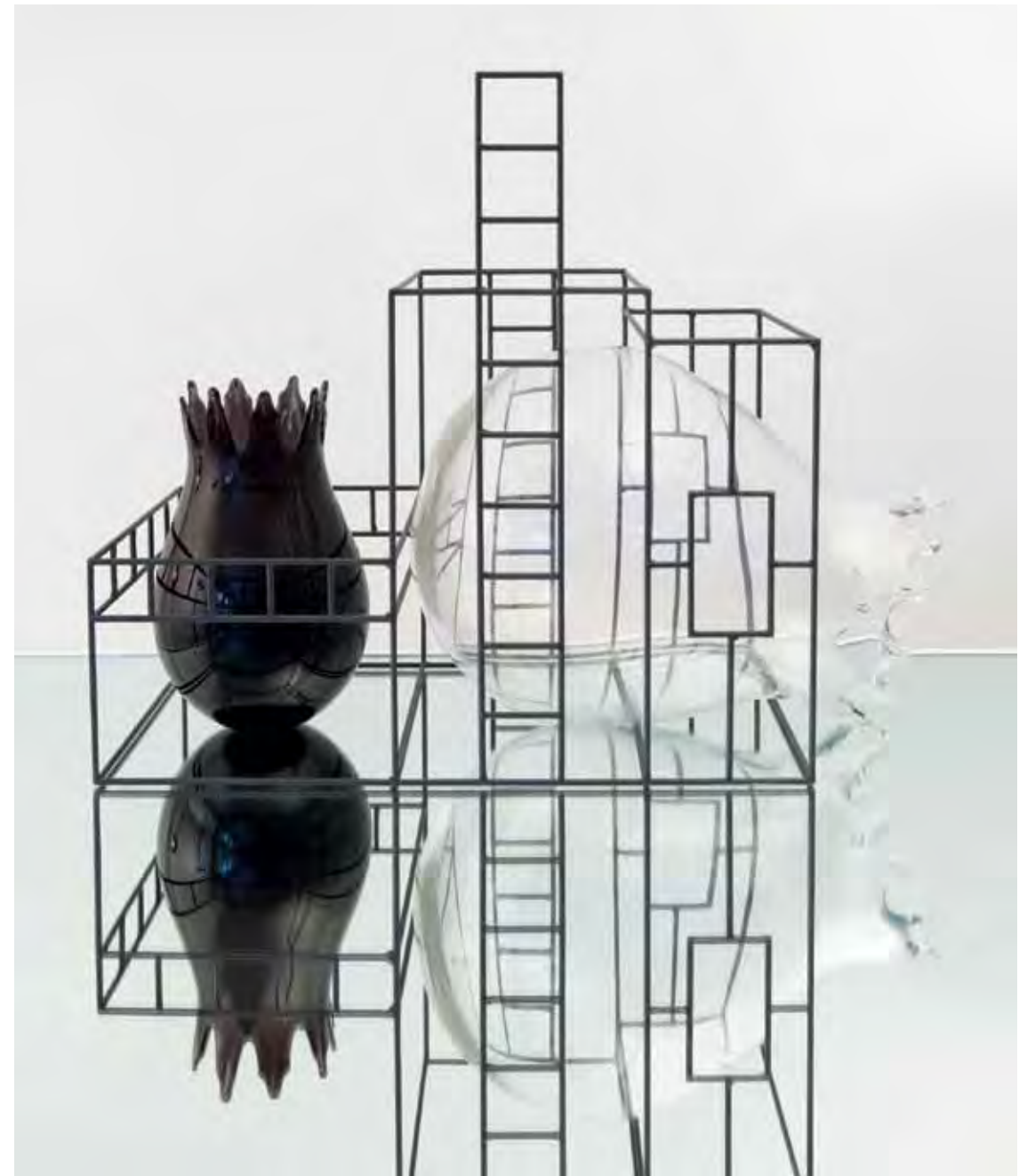
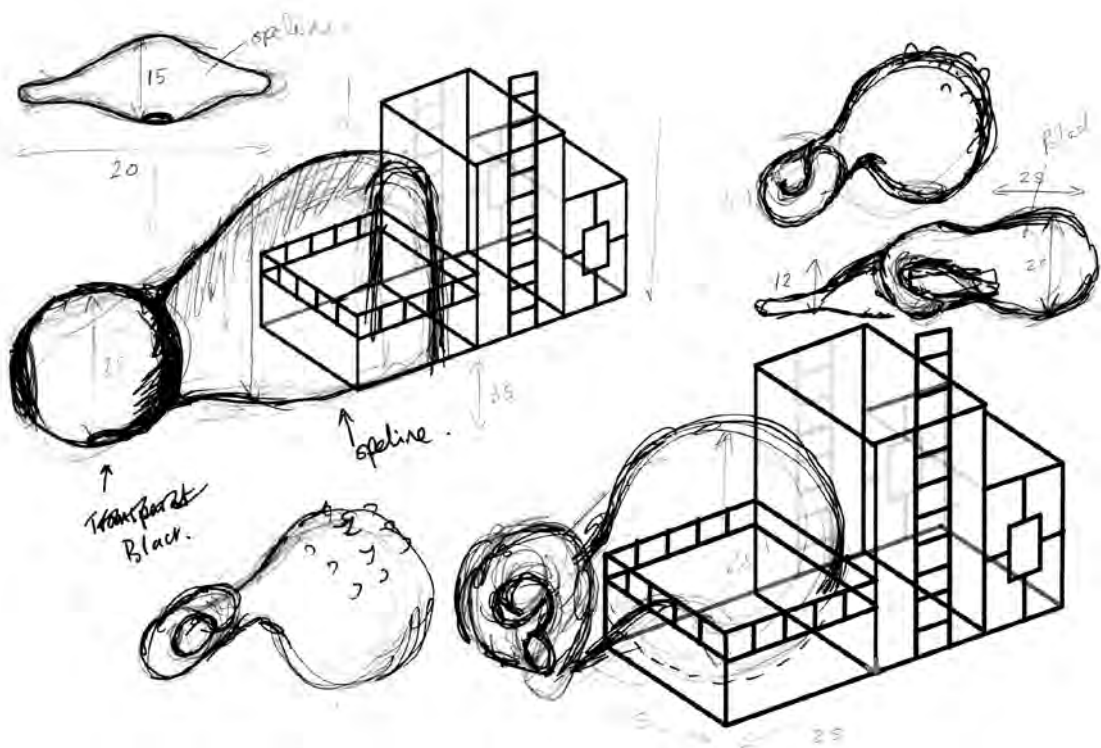

(left)  
 Totipotent Architecture - Control Tower Visitor Center, 2008  
 Sketchbook drawing

(right)  
 Totipotent Architecture - Greenham Common Visitor Center, 2008

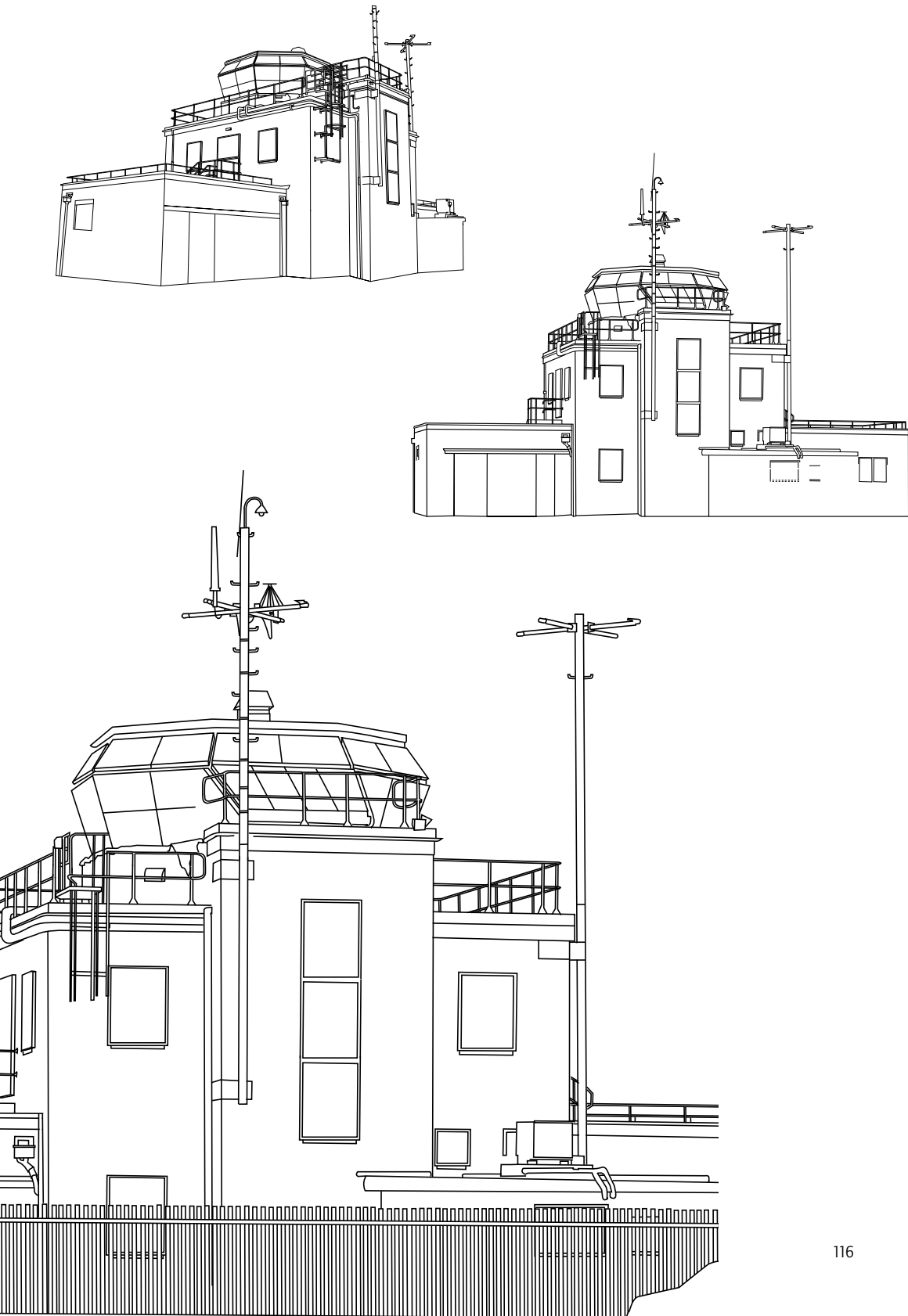

---

SASHA ROSENEIL

---

# Architectures of Resistance and Transformation

## Re-encountering the queer spaces and relationality of Greenham Common

"You'd get this sort of freedom to let your mind wander outside its normal confines, which you can't do if you're confined by a building, and your thoughts are shaped by that building. If you sit around a fire, it's dark, and after a while you could be living in any century, and any country, and your whole being is totally free from those restrictions. Women felt outside normal behavior."

Carmel Cadden, Peace Camper, on living at the Greenham Common Women's Peace Camp

Back in the early 1980s, Margaret Thatcher was Prime Minister, Ronald Reagan was in the White House, and the Cold War had been reignited. NATO was stationing a new generation of cruise and Pershing intercontinental nuclear missiles across Western Europe and the Soviet Union was doing the same in the east.

In this context, Her Majesty's Government produced a booklet, *Protect and Survive*, which was to be delivered to every household in Britain should the threat of nuclear war escalate significantly and was also available for sale to those of a survivalist mentality who wished to prepare themselves in advance.

*Protect and Survive* instructed the man of the nuclear family, through clear line drawings, how to create a "fall out room" that would (supposedly) be shielded from radioactive fallout, and how to build a refuge within the fallout room—by removing doors from their hinges and creating a lean-to shelter, weighed down with bags of earth. Food should be gathered, ready for the moment when the family would enter the shelter to face their future, crammed together as the bombs rained down outside.

In 1981 a group of women organized a walk from South Wales to the United States air force base at Greenham Common to protest plans to install cruise missiles there. When the government and media failed to heed their calls for a public debate between the women protesters and the British Minister of Defence, they chained themselves to the gates of the base, echoing the tactics of the suffragettes, and the Women's Peace Camp began. Greenham became the focus for a new wave of feminist antinuclear activism and an inspiration for the peace movement across Europe and beyond, mobilizing over the years many tens of thousands of women, who went to the camp for a few hours, a few days, or made their home there for months and sometimes years.

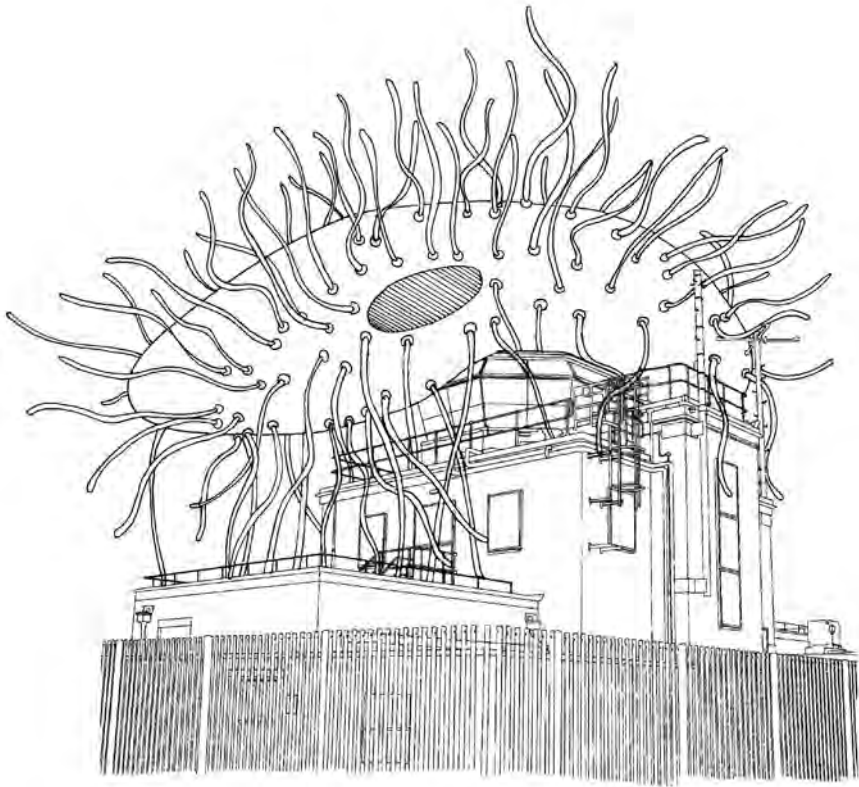

There is much to be said about the cultural significance and impact of Greenham, but to bring the memory of Greenham into dialogue with Lucy + Jorge Orta's work, I will focus on the queer architectures of Greenham's opposition to nuclear weapons and to the militarized power relations that divide the peoples of the world. Orta's work might be read as speaking directly to, and against, such systems of social organization.

Women from all over Britain and beyond, aged from their mid-teens to their 70s and 80s, left their homes, and sometimes their families, to go to Greenham. They were from all class backgrounds, and many different occupations. They had previously been politically active as socialists, anarchists, communists, environmentalists, animal liberationists, liberals, Quakers, trade unionists, students, and feminists of every hue—and some were political novices. They arrived as unquestioning heterosexuals, occasional bisexuals, and con-

firmed lesbians. Together they built a community of protest in which domestic life was lived outdoors, in which homes were turned inside out, and conventions turned upside down.

Sleeping shelters, or "benders," were built from plastic sheeting, canvas, and string; meals were cooked on open fires, which burnt wood gathered from the Common that had to be chopped and stored. Greenham women had to develop new skills and capacities: the practical, outdoor survival skills that had, during the past hundred years or so, become increasingly gendered masculine; the political skills and courage to speak in public and explain their work at the hundreds of meetings and rallies to which they were invited; the personal confidence to talk to the media, to represent themselves and claim their voices as actors on the global stage.

In so doing they questioned and transformed themselves, redesigning the relations of gender and sexu-

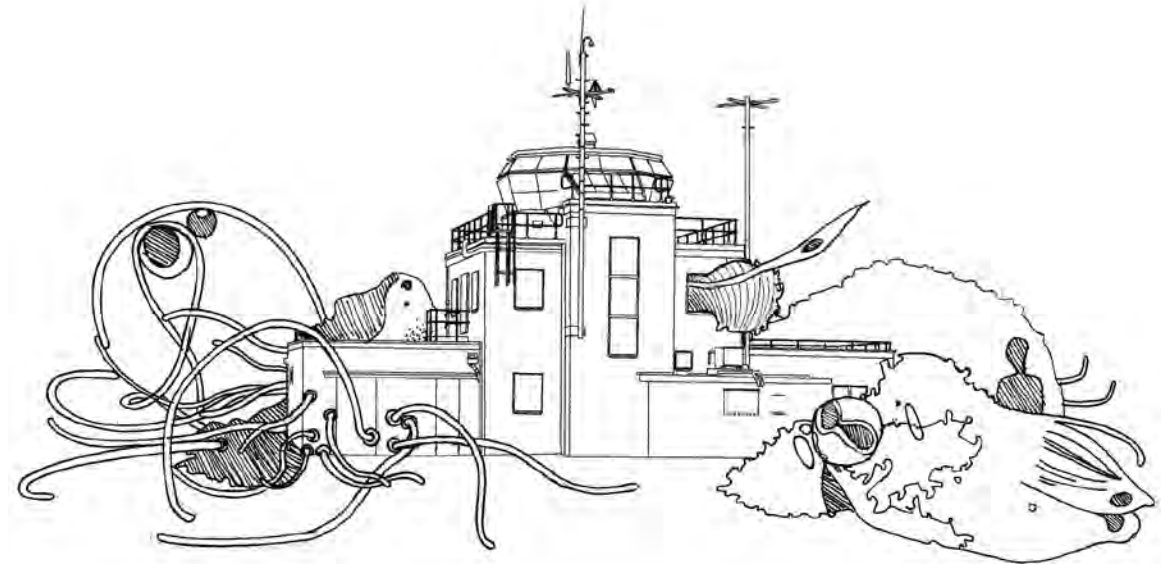

ality by which they had lived as they began to think and feel differently about what it might mean to be a woman in a male-dominated, unequal world.

At Greenham, personal life was radically de-privatized—and eating, sleeping, and even toileting were politicized. Food was collectively provisioned, and the politics and ethics of what was eaten were fiercely debated. Conventional family life, and the heterosexuality and monogamy on which it is built, were named and critiqued as women found themselves developing close, sometimes sexual, relationships of love and friendship with the other women with whom they were living and protesting. Bodies that sat together around the fire often lay down to sleep together in large communal benders, or just under the stars. Daily ablutions were carried out outside, showers fabricated and strung up in trees, water heated on the fire. Shit-pits were dug and moved around, so as to live lightly on the land.

The liminal space of this women's community, which was right up against the fences of patriarchal militarism, constituted a prefigurative, utopian world apart, where radically counternormative ways of being and living were forged. And the state objected.

Over and over again the camp was evicted—initially from the Ministry of Defence and Ministry of Transport land occupied by the Main Gate camp, and later, after a change in the law, from the common land on which the other camps were based.

For several years evictions took place up to three times a day, seven days a week—a cat and mouse game between the specially appointed team of bailiffs and the women. But Greenham fundamentally queered the norms of political protest. It tested the tolerance of a liberal democratic state that allows dissent as long as, at the end of the day, protesters pack up their banners and

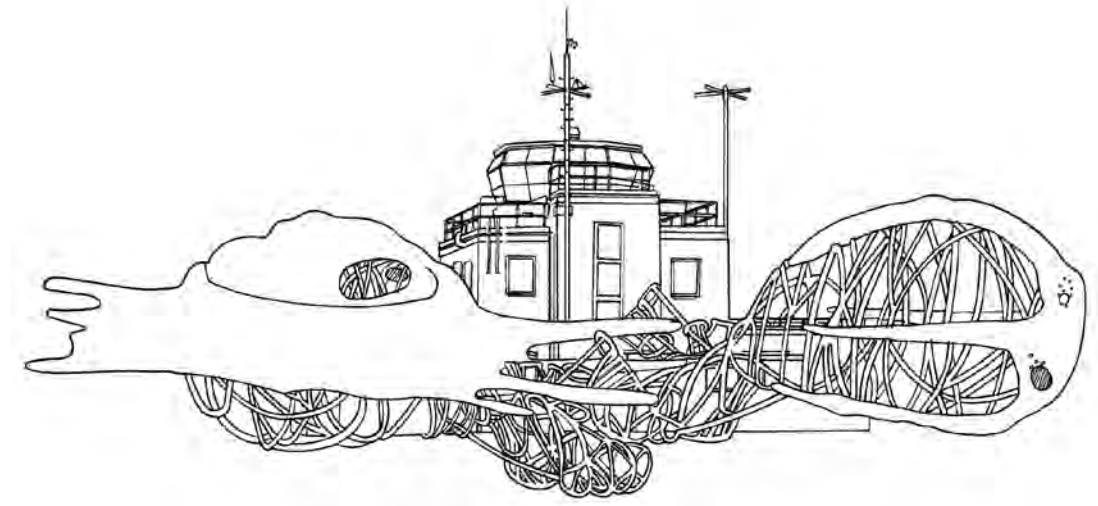
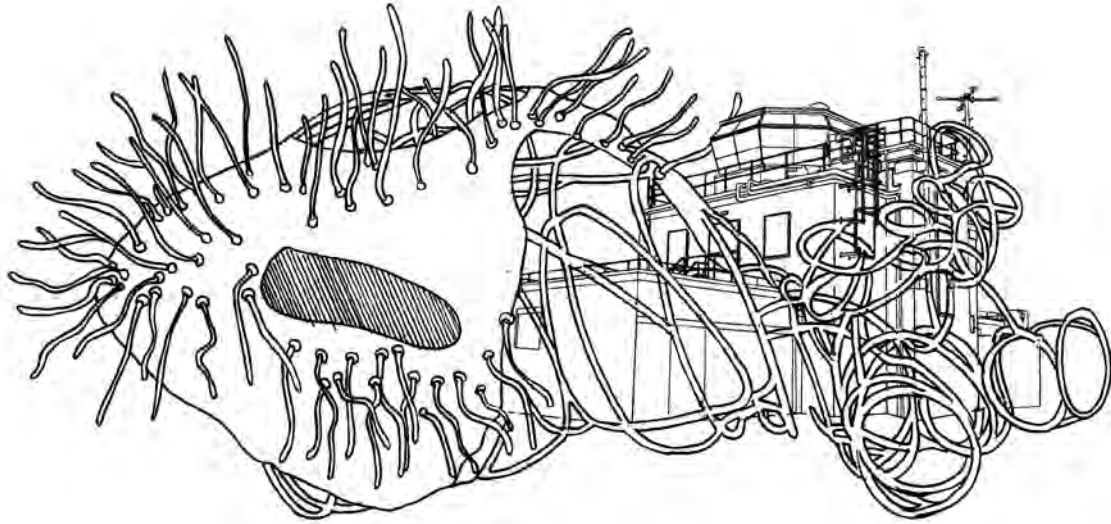

head back to their families, returning to the project of reproducing the status quo. The women of Greenham would not give up—they would not go home, as the tabloid press and politicians so regularly instructed them.

And this was, in large part, because Greenham became home, and the bonds of friendship, care, affection, and love forged at Greenham became the life-sustaining forces, the architectures of life, that women were choosing over the homes, families, and social structures whence they came. Greenham made a queer home—it was a home of women choosing to live and act without men, unprotected and unfortified by husbands and fathers. It was a home that was open to the elements, to the gaze and scrutiny of the world's media, and to vigilante violence by groups of men, both the soldiers and policemen sanctioned by the state as well as those acting less legally, who attacked women in their tents and benders, and

around the campfires, with bricks and stones and red-hot pokers and verbal abuse.

Greenham was a home open to any woman who wished to make it one—there was no membership test to pass, no rent or fee to pay, no set of beliefs to sign up to in advance. Women came and went as they pleased, passing through and settling, settling and passing through. It was a fluid home, that moved around, never quite landing up in exactly the same spot twice after each eviction, and gradually, over time, constituted of fewer and fewer possessions, and less and less domestic comfort. The caravans and real mattresses of the first year gave way to benders and tents with straw-filled bunks, and finally just Goretex sleeping bags under plastic sheeting, which is, of course, the mirror opposite of normal life, where domestic time and progression through a normative life course are marked by the acquisition of things and the accretion of domestic comforts.

Greenham was a home that rested on a belief in the commons and in shared custodianship of the earth. It resisted claims to ownership of the land that it occupied, and the well-intentioned offers of wealthy supporters to buy adjacent land to make the camp permanent. It was a home in which debate, disagreement, difference, diversity, and sheer, obstinate individuality were valued, while also emphasizing communality, collective decision-making, equality, and participation. It was a home that sought constantly to decenter itself—to resist the centripetal forces of the movements that looked toward it to provide continuity and leadership, looking instead outward to anti-imperialist, antinuclear, and feminist struggles across the world in Nicaragua, Namibia, South Africa, indigenous communities in Australia and the Pacific Islands, as well as in mining communities, women's aid and rape crisis centers nearer to home. And Greenham was a home that ultimately dissipated as its inhabitants moved on to

other things, leaving only the traces of its history on the Common.

The making of homes in public, the political act of "occupation" as a form of resistance, has recently been revived on a global scale with the wave of Occupy protests in Western cities, the persistent encampments of the "indignados" in austerity-riven southern Europe, and the protests of the Arab Spring. The tents and outdoor sleeping of today's protesters echo the repertoire of action inaugurated by Greenham, and their fluid, non-hierarchical, networked forms of organization resonate with the architectures of resistance that Greenham, over three decades earlier, referred to as "weaving the web." Creating connections among people that operate laterally rather than vertically, that might seem fragile but are actually highly tensile and resilient, there is a powerful synergy between these new modes of political relationality and the social bonds of, and through which, the Orta's work speaks.

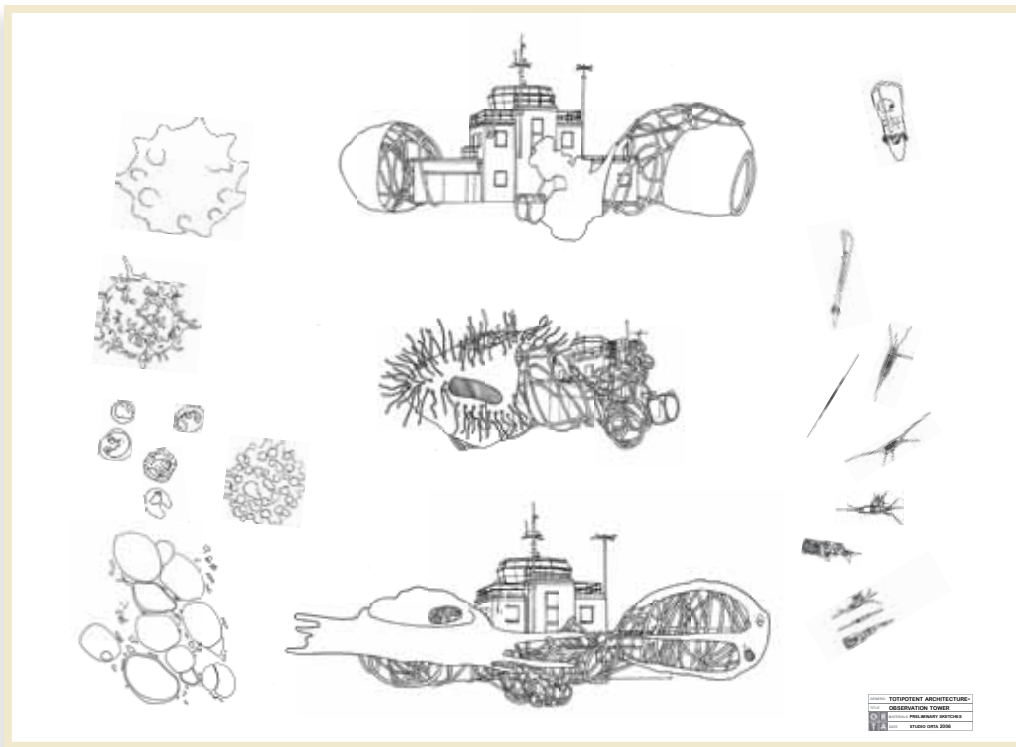
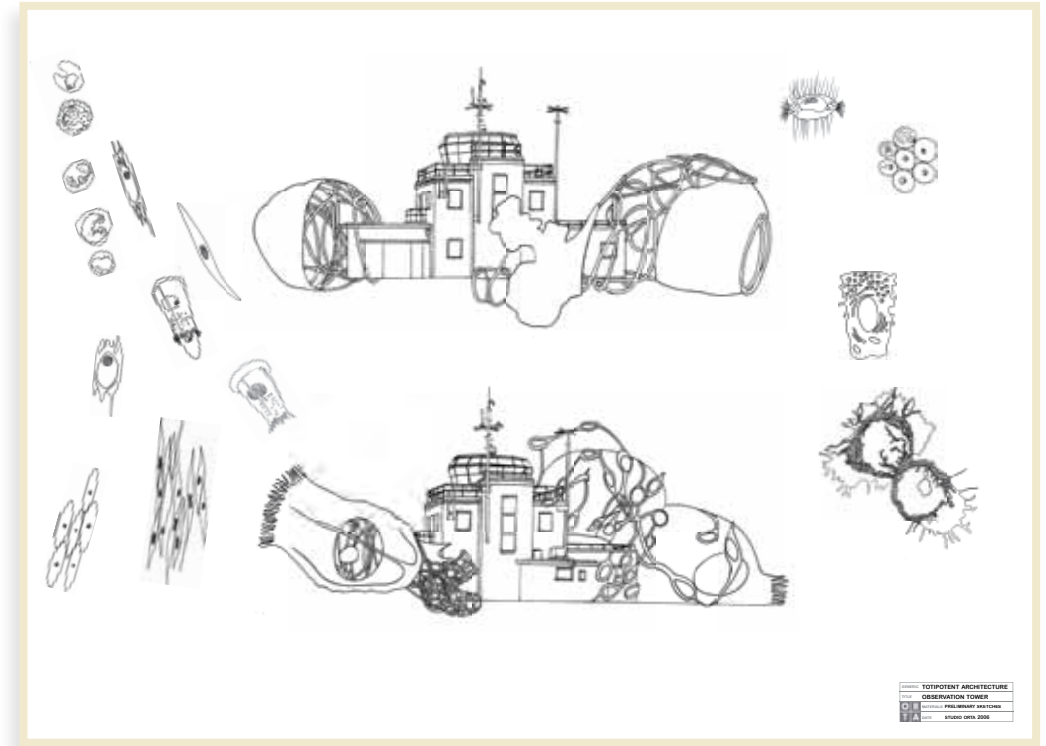
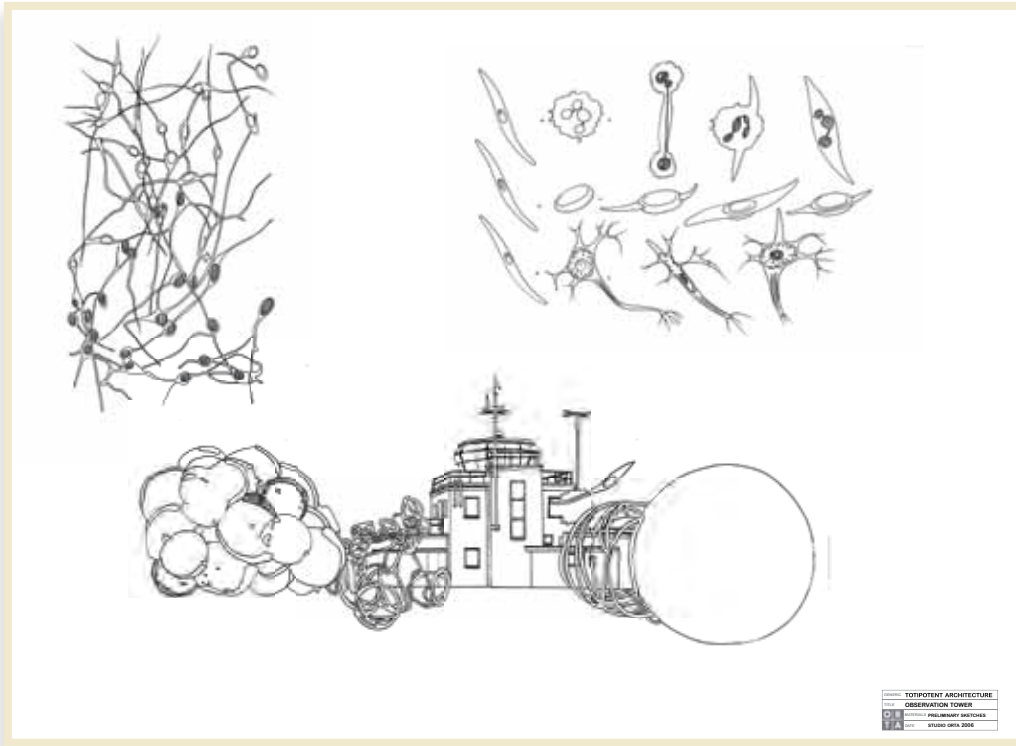

*(left & right)*  
**Totipotent Architecture - Greenham Common Control Tower, 2007**  
 Pencil, pigment ink on Fabriano paper  
 92.5 x 4 x 72.5cm (box framed)



Totipotent Architecture - Greenham Common Control Tower, 2009-13



*(left)*  
Totipotent Architecture - Greenham Common Observatory, 2008

*(right)*  
Totipotent Architecture - Greenham Common Observatory Variant, 2009-13



*(left)*  
Totipotent Architecture - Observatory in Red, 2009-13

*(right)*  
Totipotent Architecture - Greenham Common Visitors Center, 2008



# Potential Architecture Greenham Common Control Tower

In June 2012 Professor Lucy Orta became a Design Fellow of the Arts University Bournemouth. The values embodied in the work of Lucy + Jorge Orta echo those of the University, which strives for an interdisciplinary context to develop multiple forms of creative practice in art, design, media, and performance. The Arts University Bournemouth is founded on creative studio practices enhancing individual specialisms alongside complementary disciplines. Students are encouraged to be both skilled and critical in their own field, and to be able to contribute to and draw from interdisciplinary working.

In keeping with the spirit of our mission, and with that of Lucy+Jorge Orta, Lucy Orta proposed to conduct a project with first year students in the Masters of Architecture program. The brief absorbed the students (Nicole Dobbie, Ali Jafari, Melanie Kaviani, and Andrei Keltos), who were asked to find creative responses to Orta's *Totipotent Architecture - Greenham Common Control Tower* artworks developed from the artists' considerable on-site research over a four-year period (2004–2008). *Totipotent Architecture* consists of a series

of small, architecture-like sculptures (maquettes) employing the technique of blown glass (organic shapes) and steel (contours of the building), as well as drawings showing cell-like structures emerging (or perhaps exploding), in this case from the Greenham Common Control Tower that overlooks the former RAF station and later Cold War US air base. In this collaboration, the students saw themselves as both interpreters and co-creators. In discussion with Lucy Orta, Sasha Roseneil, Professor of Sociology and Social Theory at Birkbeck College, and Ed Frith, architect and Arts University Bournemouth Masters Course Leader, the students explored ways of transforming the Control Tower and interpreting the *Totipotent Architecture* project into architectural propositions. The aim was to return the building to "usefulness" as a community asset, while establishing a memorial to both the converging histories of the airfield and the Peace Camps.

The resulting student proposals are an attempt to balance the role of the building as memorial, museum, and municipal venue, addressing the transformation from military to civic. The bound-

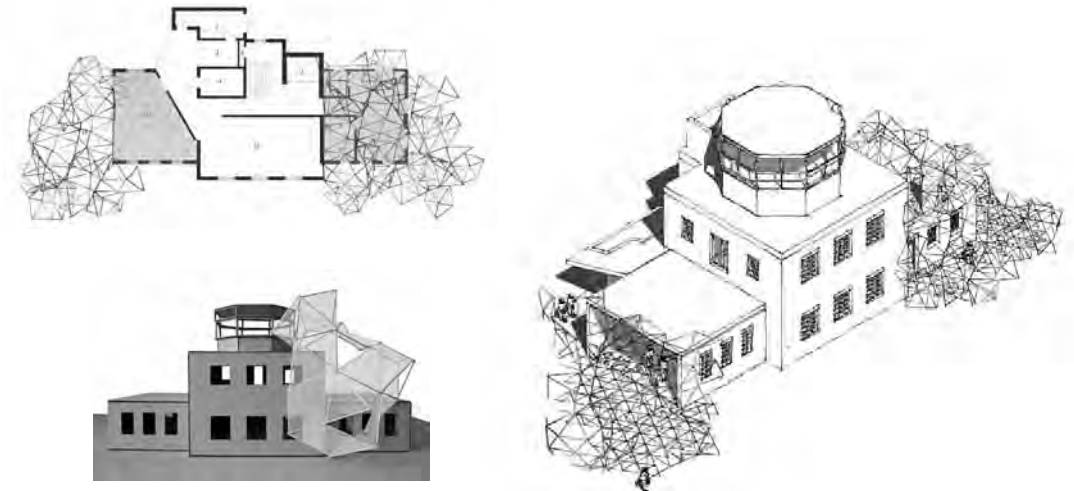

aries between landscape and building are merged to create a variety of inhabitable places for organized or *ad hoc* events: public and intimate, large or small. The former brick structure has been clad in metal frames, mesh, and glass, and reflected in pools of water. The suggestions are by no means definitive, but move the proposal into the materials and processes of construction, integrating the practical and utilitarian into a combination of old and new structures. These proposals test totipotent cellular differentiation as generative ideas in concept and material and extend Orta's temporary interventions into a more permanent architectural presence.

In Autumn 2013 TheGallery at Arts University Bournemouth exhibited a selection of Orta's *Totipotent Architecture* works. As part of this exhibition, further groups of students from different specialisms, including architecture, textile, model making, and fine art, respond once again to the work on view through collaborative making. Lucy + Jorge Orta provide a vital precedent for contemporary practice that demands and deserves our attention.

—  
Simon Beeson, Course Leader, BA (Hons) Architecture  
Professor Stephanie James, Head of the School of Visual Arts



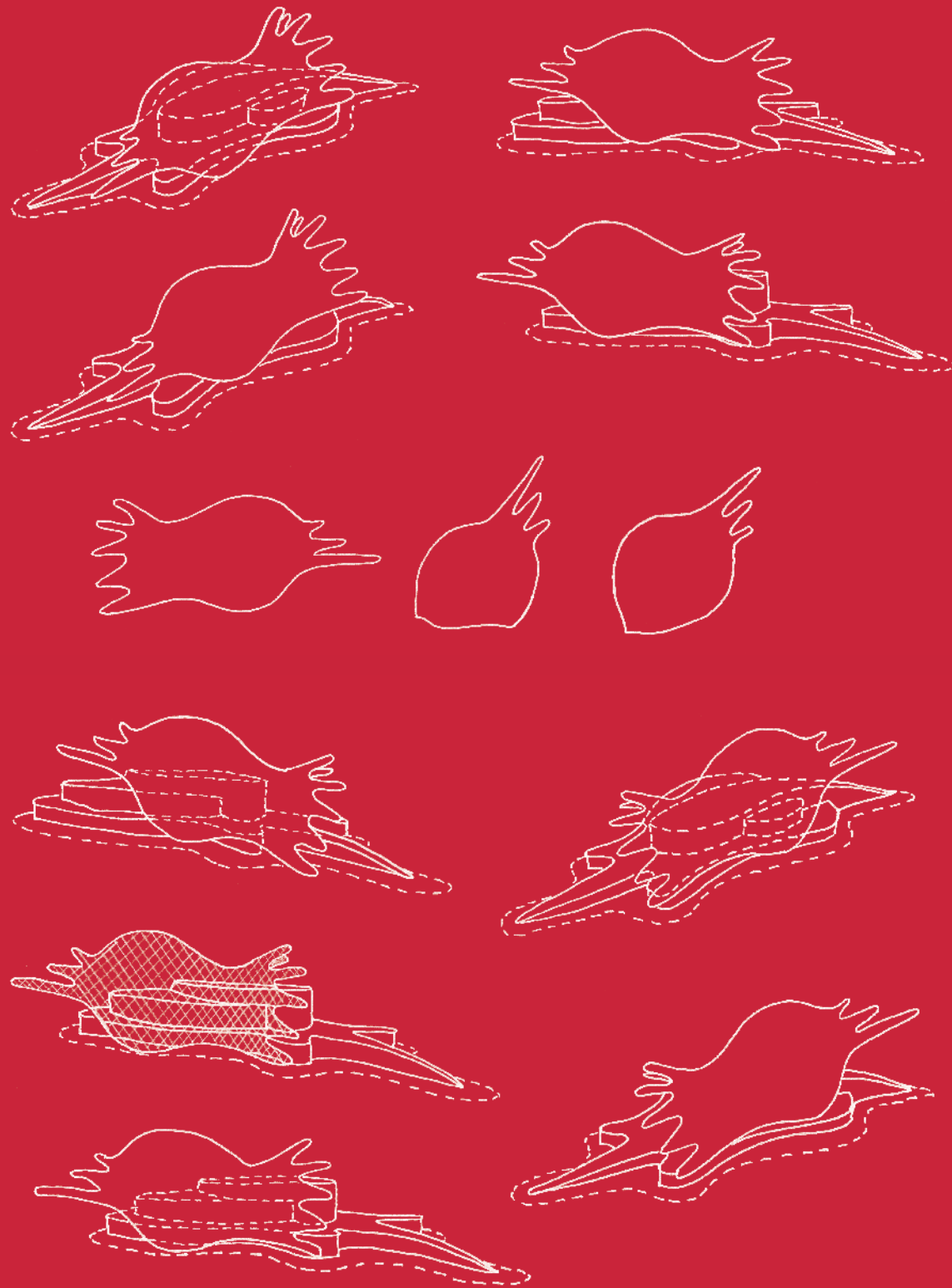

FRANCESCA COMISSO

## Totipotent Architecture Atoll

*I hope the research we conduct will amplify a power to communicate, negotiating social bonds and uniting members of a community.*

Lucy + Jorge Orta

### Potential Architecture

A large, inhabitable sculpture with a cellular organic form rises from the grass of the Corso Tazzoli public park facing the Fiat Mirafiori car manufacturing plant in Turin.

This is a meeting place, the realization of a wish made by a group of "patrons," in this case students from two neighborhood schools. An "atoll," a "kind of free port," in their words. Lucy + Jorge Orta propose *Totipotent Architecture*: beginning with a stem cell—the unit of unlimited potential that presides over the construction of an entire organism—the artists have created a metaphor of a space for social interaction that changes according to how it is used. This potential is illustrated by the imprints of the students' bodies: casts made in aluminum and then sunk into the sculpture's three cement steps. Hands, shoes, backs, and buttocks all make up a series of ghost figures on the surface, inviting whomever climbs onto the sculpture to take a position that encourages nearness and contact.

By the time it was inaugurated in spring 2007, the work had already become a household name in

Turin. Some called it the "armadillo," while to others it was known as the "iron mask," or the "spaceship." Each name derives from how the sculpture looks from a given point of view, a particular way of contemplating and imagining it. I like to perceive it as the result of an act of familiarity, of tension in identifying the places that take space away from apathy and make it part of a mental geography as a premise to the various forms of inhabiting.

Patronage for this work began in 2003 with a debate involving the student patrons and cultural mediators on how public space relates to young people; on the various forms of accessibility, belonging, and exclusion; and on the issues of visibility and safety. The patrons' answer was to create something different from what the neighborhood already had in terms of places for young people to meet. First and foremost this difference consisted of the idea of a "transversal" area that, instead of the functions of recreation, play, sport, and creativity, would offer potential to a community or to a tribe of users, a group of people who, by their actions time after time, could contribute to redefining its sense. Projected onto the scene of urban

life, marked as it is by far-reaching change and its transformation by the media into a constant state of alarm, was a call for a place of interrelating, far from any nostalgia for a lost community and aware of the risks of producing something closed and exclusive.

Entrusted with the project in 2004, Orta developed these issues with the patrons by listening and exchanging views—an approach that marks the procedural and participatory nature of all their projects, leading up to a sculpture that combines being a sculpture with being a device. A “monument” against the idea of standardization, rubber-massified stamping, or the formatting of behavior patterns in precodified ways, times, and places, but still an example of fluid architecture, which by its sinuosity of line can adapt to the many ways of social exchange and take shape with them as a catalyst for community practices. It is the never-ending process of communication and exchange that presides over how our body cells develop, their progressive specialization as individual vital functions. This provides the artists with the metaphorical scenario of a social organism that stems from the coming together of different entities, their creative energy, and cooperation among them. It is the first example of a public work in the *Totipotent Architecture* series, a cycle of works for which research into social architecture developed

from the *Refuge Wear* series (1992–1998)—mobile, temporary architectures that envelop and protect the body—and *Nexus Architecture* (from 1993)—connective systems ranging from the individual to the broader context of the socio-urban context.

### The house is the body

*Refuge Wear, Body Architecture, Modular Architecture, Nexus Architecture, Totipotent Architecture.* In the progressive augmentation of scale, from apparel to architecture to urban planning, from singularity to plurality, the body is the constant, indispensable yardstick for redefining the relationship between the individual and his or her surroundings from the standpoint of measuring artistic practice against the most burning social, humanitarian, and environmental issues that afflict the global reality of this late-modern age.

Heidegger’s assumption “man is insofar as he dwells” can be interpreted as a natural right that needs a place to manifest itself, not merely the occupation of a territory.<sup>1</sup> Orta returns our attention to this fundamental right of the subject that is both biological and political, beginning with the plight of the homeless, the refugees, the outcasts—those who have lost the link to a territory and the sense of belonging to it. The home shrinks, it clings to the body like a second skin. A costume-refuge that reclaims space, opening

up to be a tent, shifting the boundaries between inside and outside, public and private, and—in the multiple or modular declination of single living units—placing the individual in coexistence with the collective—the personal and the shared (*Body Architecture, Modular Architecture*). The high-tech fabrics and the visually strong design in this and the later series work as a screen and interface to protect the body from the environment; they provide a refuge, they are home and indicators of a presence. Interwoven with symbols, images, and phrases, and conceived in cooperation with their intended beneficiaries, they enhance the communicative power, providing the frame within which the individual narratives can manifest. “Me, I’ve got a lot to say,” said one of the participants during one of the first workshops run by the artists. This has become the paradigmatic opening line of a speech that blends philosophical, scientific, and political thought with common language and, through being visible, takes on a new assertive force. A visibility that Lucy + Jorge Orta extend to the whole social body by means of the connective systems of *Nexus Architecture*.

Beginning with the repetition of every acquired custom and idea brought on by states of crisis or emergency—a sign of today’s reality and a resounding manifestation of the common conditions of town living, such as isolation, the feeling of social

distance, and rootlessness—the artists supply an essential interpretation of the concept of home, no longer a defined place in space but the existential condition of being in space, now only mediated by the body and by how it relates to other human beings. From the suit of clothes to the tent, to the temporary village, the shift happens in the passage from the isolated individual to his binding himself to other pivotal individuals. The accessories to this link function as “doors and bridges” that enable people to unite and separate, making them simultaneously independent and interdependent.<sup>2</sup> Bodies congregate in living units (*Body Architecture*) or stretch through space, all linked together (*Nexus Architecture*). As Paul Virilio wrote on Lucy Orta’s practice, “at a time when we are told that men are free, emancipated, totally autonomous, she tells us that, on the contrary, there is a threat and that man is regrouping...the warmth of one gives warmth to the other. The physical link weaves a social link.”<sup>3</sup>

The constituent meaning of this relation can be traced back to the concept of “being a plural singular,” a concept formulated by Jean-Luc Nancy as a principle of co-essence that “has its very essence in the stroke, in the hyphen stroke which is also separator stroke, a stroke that divides.” According to Nancy, from Rousseau to Nietzsche, from Marx to Heidegger, “the investigation into being arrives at ‘we are’ as a way of expressing the being that

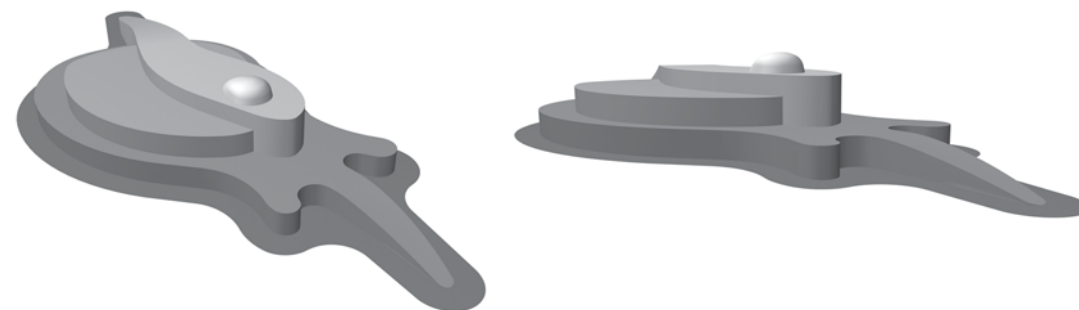
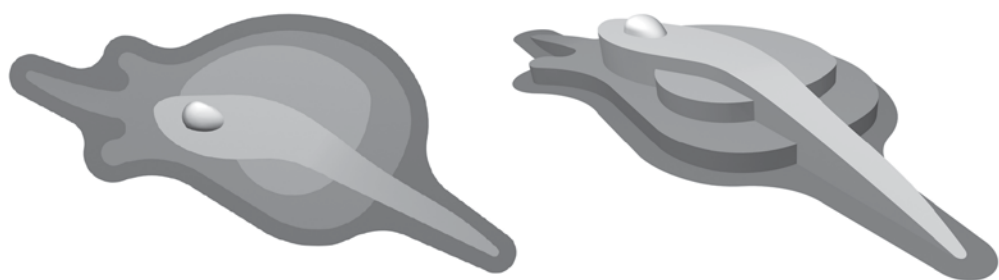

overturns the meaning and the syntax of ontology turning it into a 'sociality.'" In this sense, "the combination of singulars is singularity 'itself'; it assembles the singulars only insofar as it spaces them, and 'links' them only insofar as it does not unify them."<sup>4</sup> The nature of the Mirafiori Nord "atoll house" is in accord with this co-essence. From the *singular plural* dynamics that tell of its destiny of being a place to meet, the totipotent social architecture encompasses many of the issues that we have already looked into: protection, visibility, identity, and, above, all utopia.

*Totipotent Architecture – Atoll* responds to a request for visibility and quality aesthetics. It "marks" the surroundings and helps to redesign them by the language of art. It works like a "presence marker" in a neighborhood that typifies urban periphery, a frame for the new narratives by which each and every person can tell his or her story and see each other beyond the stereotypes by which they are talked about and looked at. In the *Atoll* identity is played out on various levels and in a variety of forms. As we have said, the sculpture is a frame and a stage for the people of the neighborhood, especially the young who attend school or live in the council houses at the edge of the park. Despite being a roomy organism and sensitive to use, the *Atoll* does not set out to be virgin territory. Its surface is "historicized" by traces: forms of seated or reclining bodies, alone or set alongside one another, nearby or brushing each other, turned to face the houses, the sky, or the flow of cars beyond the curtain of trees. The imprint of the bodies gives an indicative sign, a clue; Lucy+ Jorge Orta responded to the patrons' wish to leave their signature, record a role, a commitment, and a feeling of pride in its outcome. The artists' proposal is the result of the quest for an alternative to the name as a means of expressing identity. Entrusted to the body imprint, the "signature" becomes sensitive to its changes over time—the body grows and gets old, clothes change with fashions and as the demands of self-representation change. The mold allows identity to emerge like a territory open and

undergoing transformation, beginning with its unshakeable unity. The imprint, however, is also a void, a shape to be filled by gestures—those of children who use them to play-cook stews of grass, leaves, and nuts that have fallen from the trees, and those who are prompted in play by the positions and lower themselves into the intimacy of someone else's body.

The empty clothes installed in the exhibition spaces, the unpopulated tents and villages, and the uninhabited atoll are all metaphors for an ideal community, a timeless, placeless dream, both poetic and melancholic. However by treating the object work as prototypes and the sculptures as architecture, the artists open a functional, accessible presence ready for use around them. Lucy Orta speaks of "Functional Utopia," a theoretical operative declination of the return to utopias with which Jorge Orta drafted his *Manifesto for the Third Millennium* in 1994.<sup>5/6</sup> A possibility of being which they "set up" through urban initiatives and performances, and even beforehand in the spirit of cooperation and coauthoring that they adopt in all their projects with workshops, discussion forums, and with the contemporary contribution of a variety of social and professional actors (from local government to schoolchildren, the world of academia, and scientific and technological research, to shelters for the homeless, émigré families, and the inhabitants of an entire village).

The live presence of bodies that move united with each other (*Nexus*) or adjacent when not enveloped in a single structure lined up in formations (*Connector*) ooze a "constituent" power or, in the words of activism, given as visualizations of empowerment make an ideal space real. Rather than offering answers to the problems of our society, Orta's work raises issues and opens debate extending it to the greatest number of people. Instead of an instruction booklet the artists leave clues like the imprints in the *Atoll*, archaeological remains pointing to the future, both an inner place for the self and a way of inhabiting the world.

*Totipotent Architecture – Atoll* was realized within the New Patrons program of the Fondation de France, promoted in Italy by the Adriano Olivetti Foundation. The project was curated by the collective a.titolo (project managers: Giorgina Bertolino and Francesca Comisso) and took place in the Mirafiori Nord neighborhood in Turin as part of the "Urban 2" urban regeneration program promoted and funded by the European Commission.

—  
A version of this text was originally published in *Nuovi Committenti. Arte contemporanea, società e spazio pubblico / New Patrons. Contemporary Art, Society and Public Space*, eds. Giorgina Bertolino, et al. (Milan: Silvana Editoriale, 2008).

1. Martin Heidegger, "Costruire, abitare, pensare (1954)," in *L'urbanisme. Utopies et réalités*, ed. Françoise Choay (Paris: Éditions du Seuil, 1965).
2. Echoing George Simmel's thoughts on human beings Andrew Patrizio brings his concept of "door and bridge" to recorded representation in Lucy Orta's work. See Andrew Patrizio, "Bridges and doors: some thoughts on Lucy Orta's connector project," in *Liquid Architecture / Moving Architecture: Lucy Orta*, eds. Lucy Orta and Courtney Smith (Munich: Verlag Silke Schreiber, 2003) and *Lucy Orta Body Architecture* (Munich: Verlag Silke Schreiber, 2003).
3. Paul Virilio, *Lucy Orta: Refuge Wear* (Paris: Editions Jean-Michel Place, 1996).
4. Jean-Luc Nancy, *Être singulier pluriel* (Paris: Galilée, 1996).
5. Jade Dellinger, "Conversations, 2001-2003," in *Lucy Orta: Body Architecture* (Munich: Verlag Silke Schreiber).
6. Jorge Orta, "The Return of the Utopias: The Aesthetics of Ethics, a Draft Manifesto for the Third Millennium (November 1994)," in *Light Messenger: XLVI Venice Biennale* (Paris: Editions Jean-Michel Place, 1995).

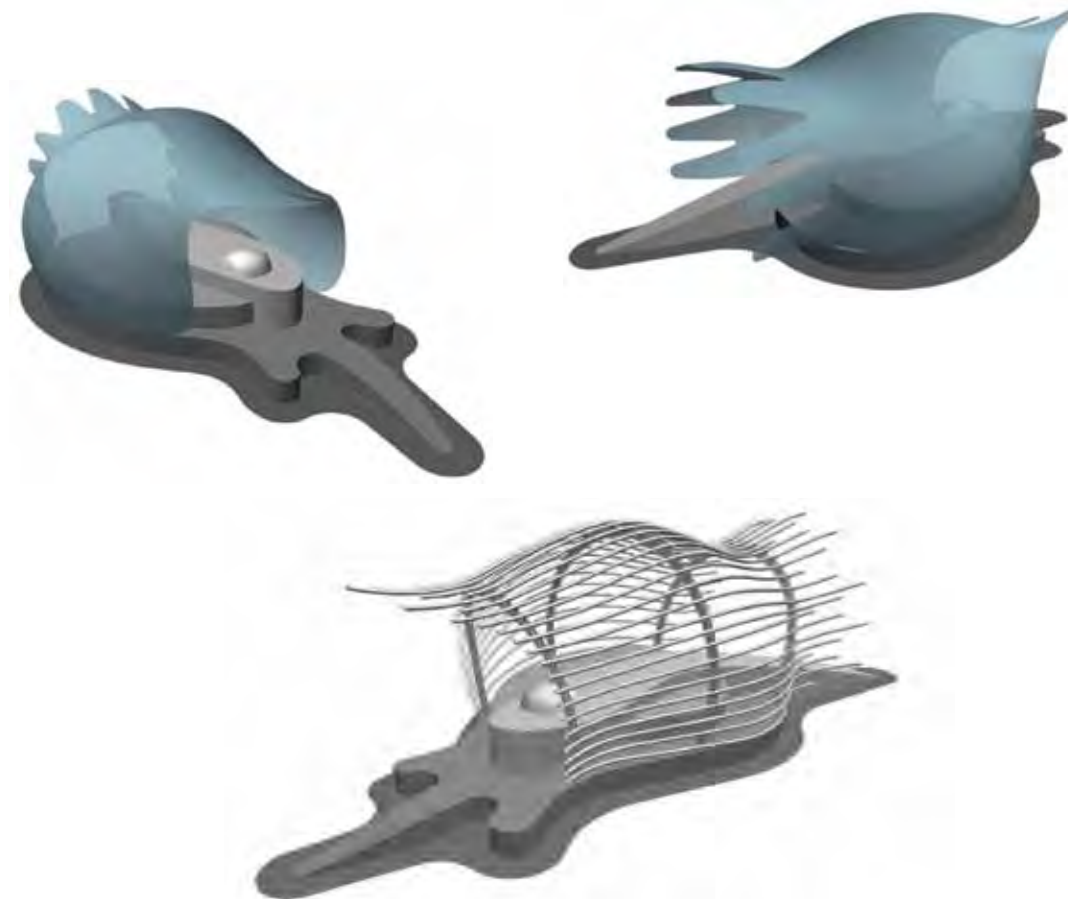









Totipotent Architecture - Atoll, 2004-07







Potential Architecture  
Nexus Bridge, Lee Bank Middleway, Birmingham

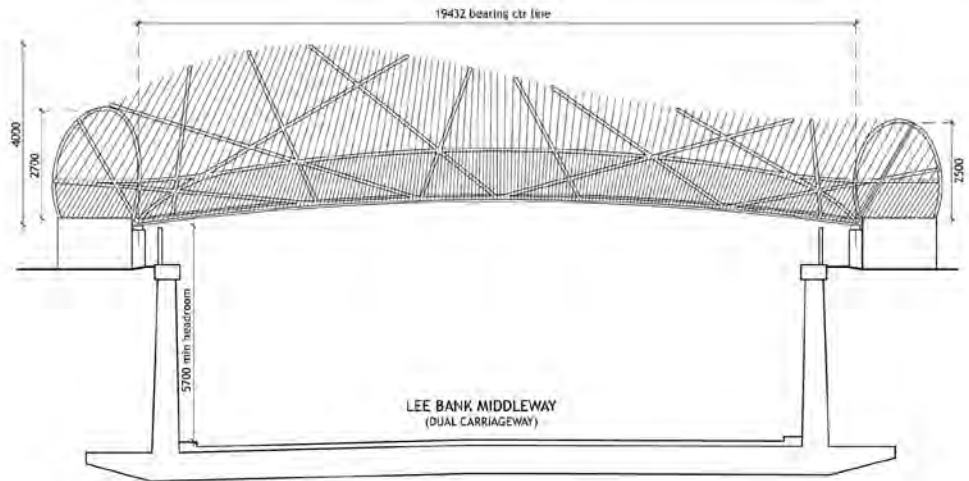
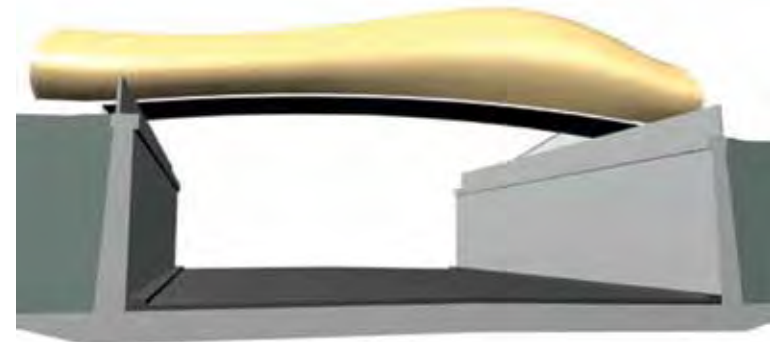
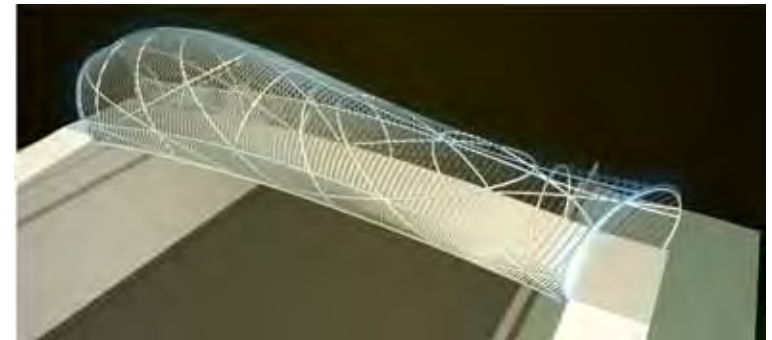
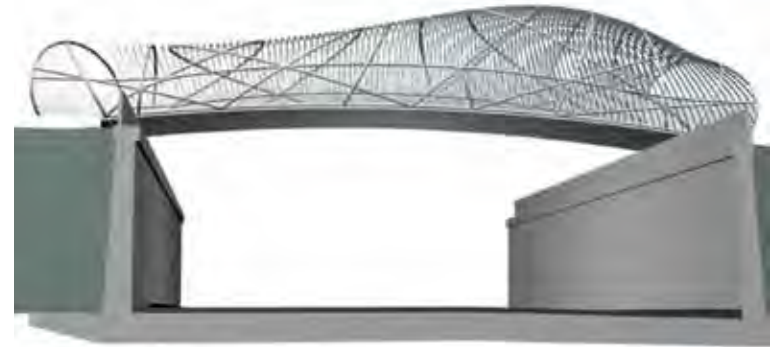

---

Potential Architecture  
Cellular Units, Cité du Design, Saint-Etienne

---

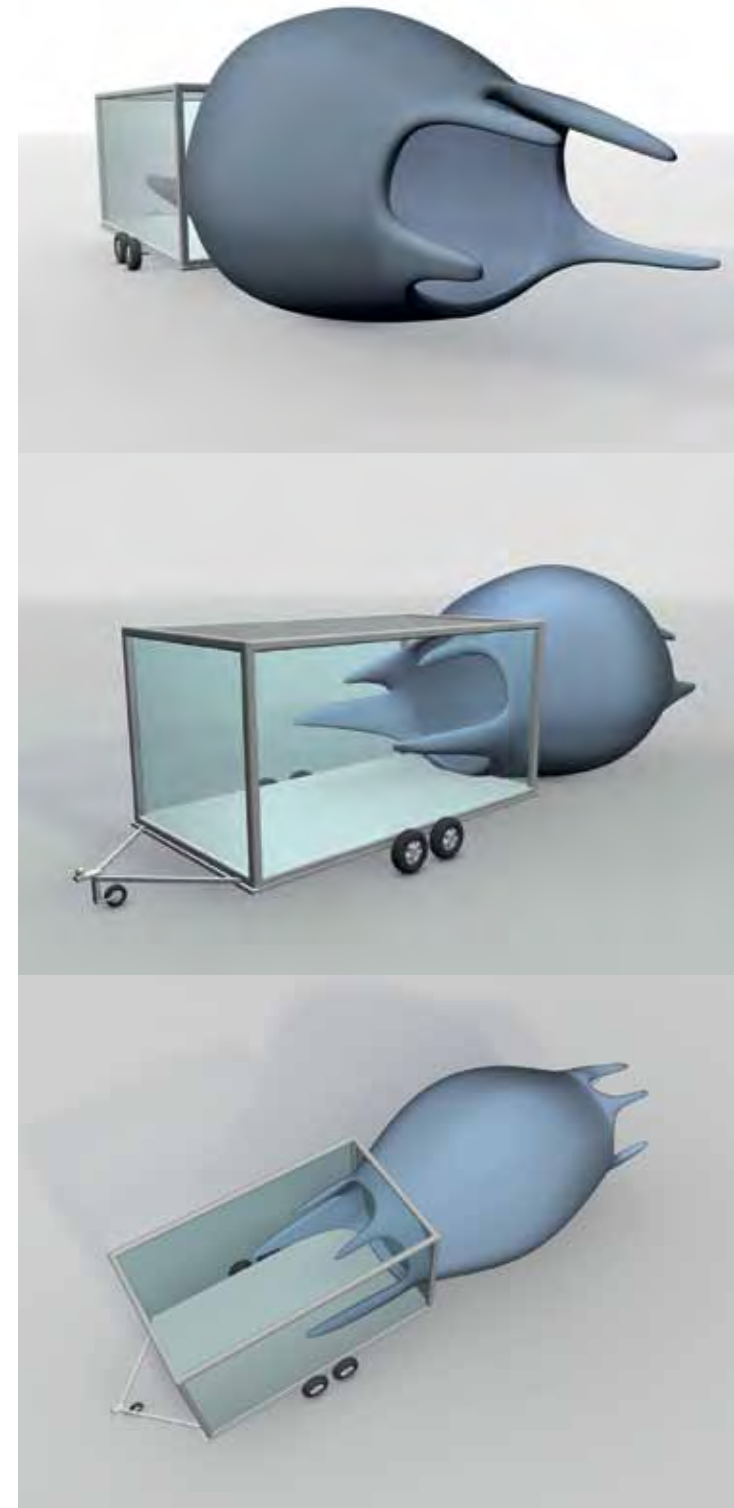
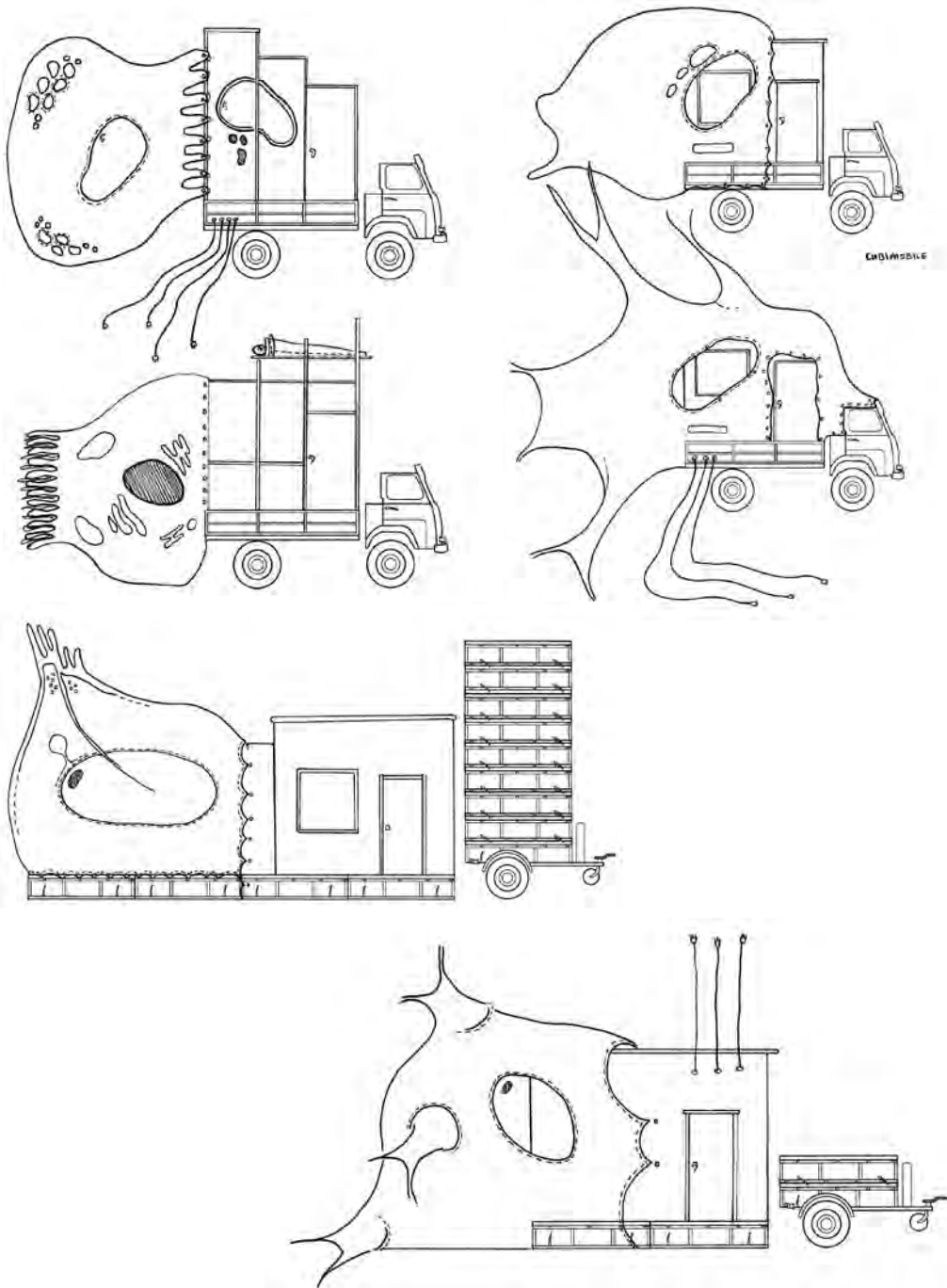



## BIOGRAPHY

### Lucy + Jorge Orta

[www.studio-orta.com](http://www.studio-orta.com)

Lucy+Jorge Orta's collaborative practice draws upon ecological and social sustainability issues to create artworks employing a diversity of mediums, including drawing, sculpture, couture, painting, silkscreen, photography, video, and light, as well as staged ephemeral interventions and performances. Their work has been the focus of major solo exhibitions at the Venice Biennale (1995); Weiner Secession, Vienna (1999); Barbican Art Gallery, London (2005); Fondazione Bevilacqua La Masa, Venice (2005); Museum Boijmans Van Beuningen, Rotterdam (2006); Galleria Continua, Beijing, San Gimignano, and Le Moulin (2007–8); the Biennial of the End of the World, Ushuaia and the Antarctic Peninsula (2007); Hangar Bicocca spazio d'arte, Milan (2008); Natural History Museum, London (2010); the Shanghai Biennale (2012); and MAXXI National Museum of XXI Century Arts, Rome (2012).

Their work can be found in public and private collections and has been the subject of numerous monographs, notably: *Clouds | Nuages*. Bologna: Damiani, 2012; *Fabulae Romanae*. Venice: Marsilio, 2012; *Lucy+Jorge Orta: Food Water Life*. New York: Princeton Architectural Press, 2011; *Light Works*. London: Black Dog Publishing, 2010; *Antarctica*. Milan: Mondadori Electa, 2008; *Lucy Orta. Contemporary Artist*. London: Phaidon Press, 2003.

**Lucy Orta** was born in 1966 in Sutton Coldfield, United Kingdom. After graduating with an honors degree in fashion-knitwear design from Nottingham Trent University in 1989, Lucy began practicing as a visual artist in Paris in 1991. Lucy was the head of Man and Humanity, a pioneering master's program that stimulates socially driven and sustainable design, which she cofounded at the Design Academy in Eindhoven in 2002. She is currently Professor of Art and the Environment at the University of the Arts London.

**Jorge Orta** was born in 1953 in Rosario, Argentina. He studied simultaneously at the faculty of fine arts (1972–79) and the faculty of architecture (1973–80) of the Universidad Nacional de Rosario. Jorge was a lecturer in the faculty of fine arts of the Universidad Nacional de Rosario and a member of CONICET, the Argentinian national council for scientific research, until 1984, when he received a scholarship from the French Ministry of Foreign and European affairs to pursue a D.E.A. (Diplôme d'études approfondies) at the Sorbonne University in Paris.

Lucy+Jorge Orta's studios are located in central Paris and at Les Moulins in Seine-et-Marne. Les Moulins is a not-for-profit cultural regeneration project founded by the artists in 2000 with a mission to transform the former industrial heritage sites along the Grand Morin River valley. These include: La Laiterie, the first industrial dairy in the region; the Moulin de Boissy, and the Moulin Sainte-Marie, two former paper mills of national historical significance.

## EXHIBITIONS SELECTION

### Solo

#### 2013

*Food Water Life*. Zilkha Gallery, Wesleyan University, Middletown, CT, United States

*Meteors | Clouds*. Terrace Wires. Barlow Shed, St Pancras International Station, London, United Kingdom

*70 x 7 The Meal act XXXIV*. Philadelphia, PA, United States of America

*Spirits of the Huveaune | Le Chemin des Fées*. Marseille-Provence, France

*Clouds*. Yorkshire Sculpture Park, Leeds, United Kingdom

*Totipotent Architecture*. TheGallery, Arts University Bournemouth, Bournemouth, United Kingdom

#### 2012

*Amazonia | Fantastic Creature*. Lille 3000, Lille Town Hall, France

*Fabulae Romanae*. MAXXI Museo Nazionale delle Arti del XXI Secolo, Rome, Italy

*Food, Water, Life*. Tufts University Art Gallery, Aidekman Arts Center, Medford, Massachusetts, United States

*70 x 7 The Meal act XXXIII*. Smiths Row, Bury St Edmunds, Suffolk, United Kingdom

#### 2011

*Clouds | Nuages*. La Maréchalerie – centre d'art contemporain, l'École nationale supérieure d'architecture de Versailles et la Gypsothèque du Musée du Louvre, France

*Amazonia*. Motive Gallery, Amsterdam, Holland

*70 x 7 The Meal act XXXII*. MAXXI Museo Nazionale delle Arti del XXI Secolo, Rome, Italy

*Antarctica*. Galerie de Marseille, France  
*70 x 7 The Meal act XXVI*. Fundació Joan Miró, Barcelona, Spain

#### 2010

*Amazonia*. Natural History Museum, London, United Kingdom

*The Gift*. Adelaide International 2010: Apart, we are together, Jam Factory, Adelaide, Australia

*Lucy Orta*. CCANW: Centre for Contemporary Art and the Natural World, Exeter, United Kingdom

*Antarctica*. Eté des Arts en Auxois-Morvan, Montbard, France

*Wijheizij - Milk*. Permekemuseum, Jabbeke, Belgium

*Light Works*. Black Dog Space, London, United Kingdom

#### 2009

*OrtaWater*. Motive Gallery / Vienna Art Fair, Austria

*OrtaWater*. DSM, Heerlen and Sittard, Holland

*70 x 7 The Meal, act XXXI*. Sherwell Church Hall, North Hill, Plymouth, United Kingdom

*Lucy Orta*. Plymouth Arts Centre / Plymouth College of Art & Design, United Kingdom

*Light Works—Brasilia em Luz*. Brasilia, Brazil

#### 2008

*Antarctica*. Galleria Continua: Le Moulin, Boissy le Châtel, France

*Antarctica*. Hangar Bicocca spazio d'arte, Milan, Italy

*Antarctic Village—13:3*. Fries Museum, Leeuwarden, Holland

*Antarctic Village—Works in Progress*. Motive Gallery, Amsterdam, Holland

*70 x 7 The Meal, act XXIX*. La Venaria Reale, Turin, Italy

*70 x 7 The Meal, act XXVIII*. Villa Ephrussi de Rothschild, Cap Ferrat, Monaco

*OrtaWater*. Expo Zaragoza 2008, Austrian Pavilion, Spain

*Body Architecture*. The Swedish Museum of Architecture, Stockholm, Sweden

*Survival*. Fashion Space Gallery, London College of Fashion, United Kingdom

#### 2007

*Antarctic Village—No Borders*. Galleria Continua: San Gimignano, Italy

*Antarctic Village—No Borders*. Antarctic Peninsula, Antarctica

*Heads or Tails, Tails or Heads*. Antarctic Marambio Base, Antarctica

*Fallujah—works in progress*. Galerie Peter Kilchmann, Zurich, Switzerland

*Fallujah*. Institute of Contemporary Art / Old Truman Brewery, London, United Kingdom

*Fallujah—Casey's Pawns*. 11th Prague Quadrennial International Exhibition of Scenography and Theatre Architecture, Czech Republic

*Fallujah*. Art Forum Berlin / Motive Gallery, Germany

*Fallujah—Auszug 01*. Context Festival, Hebbel am Ufer, Berlin, Germany

*70 x 7 The Meal, act XXVII*. Albion Gallery, London, United Kingdom

*Nexus Architecture*. Tramway, Glasgow, Scotland

#### 2006

*OrtaWater*. Galleria Continua: Beijing, China

70 x 7 *The Meal, act XXV, Open House*. Casa Argentina, London, United Kingdom  
*Light Works—Lights on Tampa*. Tampa Bay Hotel / University of Tampa, Florida, United States  
*Light Works—Open House/ Casa Abierta*. Casa Argentina, London, United Kingdom  
*Selected Works: Lucy + Jorge Orta*. Motive Gallery, Amsterdam, Holland

## 2005

*Lucy Orta*. The Curve, Barbican Centre, London, United Kingdom  
*Drink Water!* 51st Venice Biennale, Fondazione Bevilacqua La Masa, Italy  
*Water & Works*. Museum Boijmans Van Beuningen, Rotterdam, Holland  
70 x 7 *The Meal, act XXIII—Lunch with Lucy*. The Curve, Barbican Centre, London, United Kingdom  
70 x 7 *The Meal, act XXII. Z33*, Hasselt, Belgium  
70 x 7 *The Meal, act XXI*. Pleinmuseum / Centraal Museum, Utrecht, Holland  
*Totipotent Architecture*. Centre of Contemporary Visual Arts, University of Brighton, United Kingdom

## 2004

*Casey's Pawns—Nexus Architecture*. Victoria & Albert Museum, London, United Kingdom  
*Dwelling X*. RIBA, London, United Kingdom  
*Nexus Architecture x 110*. Attwood Green, Birmingham, United Kingdom  
*Light Works—Lille European Cultural Capital 2004*. Opera House, Lille, France

## 2003

70 x 7 *The Meal, act XX*. UNESCO, Paris, France  
*Connector Mobile Village*. Southeastern Center for Contemporary Art, Winston-Salem, North Carolina, United States  
*Body Architecture*. Lothringer13, Munich, Germany

*Dwelling X*. Old Market Square, Nottingham, United Kingdom  
*Collective Dwelling, act IX*. Institute for Contemporary Art, Brisbane, Australia  
*Collective Dwelling, act VIII*. Cicignon High School, Fredrikstad, Norway  
*Light Works—OPÉRA.tion Life Nexus, act IX*. 14th World Transplant Games, Place Stanislas, Nancy, France

## 2002

70 x 7 *The Meal, act XIX*. Design Academy Eindhoven, Holland  
70 x 7 *The Meal, act XVII (Enactments of the Self)*. Sterischer Herbst, Graz, Austria  
70 x 7 *The Meal, act XVII*. Rio Garonne, Toulouse, France  
70 x 7 *The Meal, act XVI. Ar/ge Kunst Museum Gallery*, Waltherplatz, Bolzano, Italy  
*Connector Body Architecture sector IX*. Musée d'Art et d'Histoire de Cholet, France

*Connector Mobile Village*. Florida Atlantic University Galleries, Boca Raton, Florida, United States  
*Nexus Architecture x 110*. Miami Design District / Art Basel Miami Beach, Miami, Florida, United States

*Fluid Architecture II workshops*. The Dairy, St Siméon, France / Stroom Den Haag, The Hague, Holland

*Fluid Architecture I workshops*. Drill Hall, Melbourne, Australia

*Light Works—OPÉRA.tion Life Nexus, act VIII*. Saint-Eustache, Paris, France

*The Gift - Life Nexus*. TwoTen Gallery, The Wellcome Trust, London, United Kingdom

*Borderline*. Berlin Ballet: Komische Oper Berlin, Germany / Compagnie Blanca Li: Créteil Maison des Arts, France

## 2001

70 x 7 *The Meal, act XIII*. Firstsite gallery, Colchester, United Kingdom

70 x 7 *The Meal, act XII*. Parc Beauvillé, Amiens, France

70 x 7 *The Meal, act XI* (They say this is the Place). Antwerp, Belgium

70 x 7 *The Meal, act X (Active Ingredients)*. COPIA: The American Center for Wine, Food and the Arts, Napa Valley, California, United States

70 x 7 *The Meal, act IX (OPÉRA.tion Life Nexus, act VII)*. Museum für Angewandte Kunst, Cologne, Germany

70 x 7 *The Meal, act V–VII*. Casa de Francia / Museo Diego Rivera/ Couvent de la Mercedes, Mexico City, Mexico

*Connector Guardian Angel sector VIII*. Casa de Francia, Mexico City, Mexico

*Connector Mobile Village sector IV*. University of South Florida Contemporary Art Museum, Tampa, Florida, United States

*Light Works—OPÉRA.tion Life Nexus, act VI—Battement des Grands Jours*. Palais de Tau / Reims Cathedral, France

*Light Works—OPÉRA.tion Nexo Corazón, act V*. Festival del Centro Histórico, El Zocalo, Mexico City, Mexico

*The Gift*. Firstsite Gallery, Colchester, United Kingdom  
*Arbor Vitae (Making History)*. Freeport Talke, Staffordshire, United Kingdom

## 2000

70 x 7 *The Meal, act IV*. Dieuze, France

70 x 7 *The Meal, act III (The Invisible Touch)*. Kunstraum Innsbruck, Austria

*Connector Mobile Village sector VII*. Talbot Rice Gallery, Edinburgh, United Kingdom

*Connector MacroWear sector VI*. Kapelica Gallery, Ljubljana, Slovenia

*Connector Mobile Village III*. Australian Centre for Contemporary Art, Melbourne, Australia

*Connector Mobile Village II*. La Cambre E.N.S.A.V., Brussels, Belgium

*Connector Mobile Village I*. Pitti Immagine, Florence, Italy

*The Gift - Life Nexus*. Cité des Sciences et de l'Industrie, Parc de la Villette, Paris, France

*Light Works—OPÉRA.tion Life Nexus, act IV Millennium*. Le Grenier du Siècle / Lieu Unique, Nantes, France

*OPÉRA.tion Life Nexus, act III*. Chapiteau Larue Foraine, Paris, France

*Light Works—OPÉRA.tion Life Nexus, act II*. Hôpital Robert Giffard, Québec, Canada

*Light Works—OPÉRA.tion Life Nexus, act I*. Festival Internacional de Arte, Medellín, Colombia

*The Gift—Life Nexus*. Athens Sculpture Biennale, Greece

*The Gift—Life Nexus*. Mediterranean seabed, France

*Jorge Orta recent works*. Galeria El Museo, Bogota, Colombia

## Collective

### 2013

*Milk | Stocked: Contemporary Art from the Grocery Aisles*. Ulrich Museum of Art, Wichita, Kansas, United States

*Amazonia | Internaturalism*. PAV Parco d'Arte Vivente, Turin, Italy

*HortiRecycling | Artists Plans for Sustainability*. Mead Gallery, Warwick Arts Centre, Warwick, United Kingdom

*Amazonia | Glasstress: White Light / White Heat*. 55th Venice Biennale, Venice, Italy

*Nexus Architecture | Hangzhou Triennial of Fiber Art*. Hangzhou, China

### 2012

*Amazonia | Spécimens: Collections, croisements, sentinelles*. Domaine de Chamarande, France  
*Antarctica World Passport Bureau*. FIAC Hors les Murs, Paris, France

*OrtaWater | Antarctica | Nexus Architecture: Reactivation*. 9th Shanghai Biennale. Power Station of Art, Shanghai, China

*Antarctica World Passport | Metisse Flag*. Festival of the World, Southbank Centre, London, United Kingdom

*Amazonia | Carbon 12: Art & Changement Climatique*. Espace Foundation EDF, Paris, France

*Amazonia | Nature's Toolbox: Biodiversity, Art & Invention*. Field Museum, Chicago, United States

*Clouds | Pandamonium 2*. World Wildlife Fund 60th Anniversary event, The Old Gate House Hyde Park, London, United Kingdom

*Six Yards Guaranteed Dutch Design*. MMKA museum voor moderne kunst Arnhem, The Netherlands  
*Replacing Home*. Jaus Gallery, Los Angeles, United States

*De larmes et d'eau fraiche*. Cité de la Mode et du Design, Paris, France

### 2011

*Unfold*. The Sheila C. Johnson Design Center at Parsons, New York, United States

*Somewhere Else / Ailleurs*. Espace culturel Louis Vuitton, Paris, France  
*You are Not Alone*. Fundacion Joan Miro Barcelona, Spain

*Living: Frontiers of Architecture III and IV*. Louisiana Museum of Modern Art, Humlebæk, Denmark

*Architectures, Dessins, Utopies. Works from the Centre National Des Arts Plastiques*, Paris. Mnac, Bucharest, Romania

*Spaceship Earth*. Centre of Contemporary Art Znaki Czasu, Torun, Poland

*Unfold*. Museum of Contemporary Photography, Chicago, United States

*Our House in the Middle of Our Street*. Maison des Arts de Malakoff, France

*Chemistry: Creating new Worlds*. Biennale Kijkdun, The Hague, The Netherlands

### 2010

*GSK Contemporary, Aware: Art Fashion Identity*. Royal Academy of Arts, London, United Kingdom

*Art et Changement Climatique*. Le Quai Angers, France  
*Antarctic Village—No Borders*. MAXXI, Rome, Italy

*A New Stance For Tomorrow: Part 3*. Sketch, London, United Kingdom

*Climate Capsules: Means of Surviving Disaster*. Museum für Kunst und Gewerbe, Hamburg, Germany

*Unfold*. Universität für Angewandte Kunst, Vienna, Austria

*Weiss (Ice-White)*. Kunstverein, Untergröningen, Germany

### 2009

*GSK Contemporary, Earth: Art of a changing world*. Royal Academy of Arts, London, United Kingdom

*Green Platform: Art Ecology Sustainability*. Palazzo Strozzi, Florence, Italy

*Dress Code*. ISELP, Brussels, Belgium  
*Pot Luck: Food and Art*. The New Art Gallery, Walsall, United Kingdom

*Intemperie: Fenomenos Esteticos da Mudanca Climatica e da Antartida*. Centro Cultural Oi Futuro, Rio de Janeiro, Brazil

*Sur Polar: Arte en Antartida*. MUTEK, Mexico City, Mexico

*Return to Function*. Madison Museum of Contemporary Art, Madison, Wisconsin, United States

*Frozen Time: Art from the Antarctic*. Stadtgalerie Kiel, Germany

*Antarctica World Passport. HEAVEN*, 2nd Athens Biennale, P. Faliro Beach, Greece

*Retreat*. KunstFort Asperen, Acquoy, Holland

*Off the Beaten Path: Violence, Women and Art*. The Stenersen Museum, Oslo, Norway

*(Un)Inhabitable? Art of Extreme Environments*. Festival @rt Outsiders 2009, Maison Européenne de la Photographie, Paris, France

*A Way Beyond Fashion.* Apexart, New York, United States

*Antarctic Village—Nuit Blanche.* FRAC Lorraine, Metz, France

*Esthétique des pôles: Le testament des glaces.* FRAC Lorraine, Metz, France

*Sphères.* Galleria Continua: Le Moulin, Boissy le Châtel, France

*AntArctica.* Haugar Vestfold Kunstmuseum, Tønsberg, Norway

*The Spectacle of the Everyday—TAMA project.* Xth Biennale de Lyon, Museum of Contemporary Art, Lyon, France

## 2008

*Life Size Utopia.* Motive Gallery, Amsterdam, Holland

*1% Water and our future.* Z33, Hasselt, Belgium

*Shelter X Survival: Alternative Homes for Fantastic Lives.* Hiroshima City Museum of Contemporary Art, Japan

*Totipotent Architecture—Skin Deep.* KunstFort Asperen, Acquoy, Holland

*Sur Polar: Arte en Antártida.* Museo de la Universidad Nacional de Tres de Febrero, Buenos Aires, Argentina

*Carried Away—Procession in Art.* MMKA, Arnhem, Holland

## 2007

*The Politics of Fear.* Albion Gallery, London, United Kingdom

*OrtaWater—Envisioning Change.* Nobel Peace Center, Oslo, Norway

*OrtaWater—Environmental Renaissance.* City Hall, San Francisco, California, United States

*OrtaWater—Dans ces eaux là.* Chateau d'Avignon, Saintes-Maries-de-la-Mer, France

*Urban Life Guard.* Galleria Continua: Le Moulin, Boissy le Châtel, France

*Antarctic Village—No Borders.* 1st Biennial of the End of the World, Ushuaia, Tierra del Fuego, Argentina

## 2006

*Nexus Architecture.* 9th Havana Biennale, La Habana Vieja, Cuba

*LESS—Alternative Strategies for Living.* PAC contemporary art museum, Milano, Italy

*This is America!* Centraal Museum, Utrecht, Holland

*Monument Minimal.* Château d'Avignon, Saintes-Maries-de-la-Mer, France

*Metro Pictures, part two.* MoCA, North Miami, Florida, United States

*Taille Humaine.* Orangerie du Sénat, Le Jardin du Luxembourg, Paris, France

*Other than Art.* G Fine Art Gallery, Washington, DC, United States

*The Fashion of Architecture.* Center for Architecture, New York, United States

*Dark Places.* The Santa Monica Museum of Art, California, United States

## 2005

*Contemporaneo Liquido.* Franco Soffiantino Gallery, Turin, Italy

*Five Rings: Ornaments of Suffering.* Fort of Exilles, Piedmont, Italy

*Fear Gear.* Roebling Hall, New York, United States

*Pattern Language: Clothing as Communicator.* Tufts University Art Gallery, Aidekman Arts Center, Medford, Massachusetts, United States

*Fée Maison.* La Briqueterie en Bourgogne, Le Creusot, France

*Est-Ouest/Nord-Sud: faire habiter l'homme, là encore, autrement.* arc-en-reve centre d'architecture, Bordeaux, France

*Art-Robe: Women Artists in a Nexus of Art and Fashion.* UNESCO, Paris, France

*On Conceptual Clothing.* Kirishima Open-Air Museum, Kagoshima, Japan

*Biennale de l'urgence en Tchétchénie.* Palais de Tokyo, Paris, France

## 2004

*On Conceptual Clothing.* Musashino Art University, Tokyo, Japan

*A Grain of Dust A Drop of Water.* Gwangju Biennale 2004, South Korea

*Totipotent Architecture (Arte all'Arte: Arte Architetura Paesaggio).* Associazione Arte Continua, Buonconvento, Italy

*The Interventionists: Art in the Social Sphere.* MASS MoCA, North Adams, Massachusetts, United States

*Flexible 4: Identities.* Kunsthallen Brandts Klædefabrik, Odense, Denmark

*The Space Between.* John Curtin Gallery, Curtin University of Technology, Perth, Australia

## 2003

*Design et Habitats.* Centre Georges Pompidou, Paris, France

*Flexible.* Whitworth Art Gallery, The University of Manchester, United Kingdom

*Creuats/Cruzados/Crossed.* CCCB, Barcelona, Spain

*Armour: The Fortification of Man.* KunstFort Asperen, Acquoy, Holland

*Nexus Architecture x 50 (Micro Utopias).* Art and Architecture Biennale, Valencia, Spain

*M.I.U. Mobile Intervention Units (Kaape Helder).* Den Helder, Holland

*Fashion: The Greatest Show on Earth.* Bellevue Art Museum, Bellevue, Washington, United States

*Doublures.* Musée national des beaux-arts du Québec, Canada

## 2002

*Connector Body Architecture.* Laing Art Gallery, Newcastle, United Kingdom

*Somewhere: Places in Refuge.* Angel Row Gallery, Nottingham, United Kingdom

*Portable Living Spaces.* The Fabric Workshop and Museum, Philadelphia, Pennsylvania, United States

*Fragilités.* Le Printemps de Septembre, Toulouse, France

## 2001

*Mobile Village: Plug In.* Westfälisches Landesmuseum für Kunst und Kulturgeschichte, Munster, Germany

*Untragbar.* Museum für Angewandte Kunst Köln, Cologne, Germany

*To the Trade.* Diverse Works Art Space, Houston, Texas, United States

*Global Tools.* Künstlerhaus Wien, Austria

*M.I.U. (Transforms).* G8 Environment Summit, Trieste, Italy

## 2000

*Dynamic City.* La Fondation pour l'Architecture, Brussels, Belgium

*Air en Forme.* Musée des Arts Décoratifs / Vitra Design Museum, Lausanne, Switzerland

*Ici On Peut Toucher.* Galerie TBN, Rennes, France

*Life Nexus Village Fete (Home).* Art Gallery of Western Australia, Perth, Australia

*Mutations/Modes 1960–2000.* Musée Galliera, Paris, France

## PUBLICATIONS SELECTION

Frisa, Maria Luisa, ed. *Lucy+Jorge Orta: Fabulae Romanae.* Venice: Marsilio, 2012.

Orta, Lucy, ed. *Lucy+Jorge Orta: Clouds | Nuages.* Bologna: Damiani Editore, 2012.

Orta, Lucy, ed. *Lucy+Jorge Orta: Operational Aesthetics.* London: University of the Arts London, 2011.

Casbon, Becca, and Megan Carey, eds. *Lucy + Jorge Orta: Food Water Life.* New York: Princeton Architectural Press, 2011.

Orta, Lucy, ed. *Lucy+Jorge Orta: Light Works.* London: Black Dog Publishing, 2010.

Pietromarchi, Bartolomeo, ed. *Antarctica.* Milan: Mondadori Electa, 2008.

Orrell, Paula, ed. *Lucy+Jorge Orta Pattern Book: An Introduction to Collaborative Practices.* London: Black Dog Publishing, 2007.

Prince, Nigel, ed. *Lucy+Jorge Orta: Collective Space.* Birmingham: Article Press, 2006.

Williams, Gilda, ed. *Lucy Orta.* Contemporary Artist. London: Phaidon Press, 2003.

Smith, Courtney, ed. *Body Architecture.* Munich: Silke Schreiber Verlag, 2003.

Budney, Jen, ed. *Process of Transformation.* Paris: Editions Jean-Michel Place, 1999.

Petigas, Catherine, ed. *Jorge Orta: Incandescence.* Paris: Editions Jean-Michel Place, 1998.

Orta, Lucy, ed. *Refuge Wear.* Paris: Editions Jean-Michel Place, 1996.

Orta, Jorge, ed. *Light Messenger.* Paris: Editions Jean-Michel Place, 1996.

Glusberg, Jorge, ed. *Jorge Orta: Transparence.* Paris: Editions Jean-Michel Place, 1996.